

K-75A/B
K-1500A/B
K-1500SP

OPERATOR'S
MANUAL

Drain Cleaning Machines



WARNING!

Read this Operator's Manual carefully before using this tool. Failure to understand and follow the contents of this manual may result in electrical shock, fire and/or serious personal injury.

RIDGID | **Kollmann**[®]

Table of Contents

Recording Form for Machine Model and Serial Number	1
General Safety	
Work Area Safety	2
Electrical Safety.....	2
Personal Safety	2
Tool Use and Care	3
Service	3
Specific Safety Information	
Drain Cleaner Safety	3
Description, Specifications and Standard Equipment	
Description	4
Specifications	4
Standard Equipment.....	4
Machine Inspection	5
Machine Set-Up	6
Operating Instructions	7
Special Procedures	
Reverse Operation	8
Cable Applications.....	8
Storing and Transporting Cable (“A” Frame Models)	9
Accessories	
Cable Selection	9
Accessories and Tools Available For Cables	10
Maintenance Instructions	
Lubrication	11
Cables	11
Clutch Jaws Replacement	11
Removing Clutch End Play.....	11
V-Belt Adjustment.....	12
Machine Storage	12
Service and Repair	12
Wiring Diagram	13-14
Lifetime Warranty	Back Cover

K-75A/B, K-1500A/B & K-1500SP Drain Cleaning Machines



Drain Cleaning Machines	
Record Serial Number below and retain product serial number which is located on nameplate.	
Serial No.	

General Safety Information

WARNING! Read and understand all instructions. Failure to follow all instructions listed below may result in electric shock, fire, and/or serious personal injury.

SAVE THESE INSTRUCTIONS!

Work Area Safety

- **Keep your work area clean and well lit.** Cluttered benches and dark areas invite accidents.
- **Do not operate tools in explosive atmospheres, such as in the presence of flammable liquids, gases, or dust.** Tools create sparks which may ignite the dust or fumes.
- **Keep bystanders, children, and visitors away while operating a tool.** Distractions can cause you to lose control.

Electrical Safety

- **Grounded tools must be plugged into an outlet, properly installed and grounded in accordance with all codes and ordinances. Never remove the grounding prong or modify the plug in any way. Do not use any adapter plugs. Check with a qualified electrician if you are in doubt as to whether the outlet is properly grounded.** If the tools should electrically malfunction or break down, grounding provides a low resistance path to carry electricity away from the user.

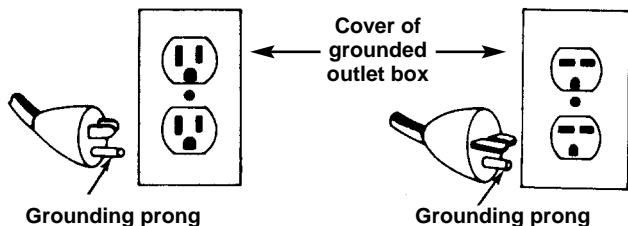

- **Avoid body contact with grounded surfaces such as pipes, radiators, ranges and refrigerators.** There is an increased risk of electrical shock if your body is grounded.
- **Don't expose electrical tools to rain or wet conditions.** Water entering a power tool will increase the risk of electrical shock.
- **Do not abuse cord. Never use the cord to carry the tools or pull the plug from an outlet. Keep cord away from heat, oil, sharp edges or moving parts. Replace damaged cords immediately.** Damaged cords increase the risk of electrical shock.

- **When operating a power tool outside, use an outdoor extension cord marked "W-A" or "W".** These cords are rated for outdoor use and reduce the risk of electrical shock.
- **Use only three-wire extension cords which have three-prong grounding plugs and three-pole receptacles which accept the machine's plug.** Use of other extension cords will not ground the tool and increase the risk of electrical shock.
- **Use proper extension cords.** (See chart.) Insufficient conductor size will cause excessive voltage drop and loss of power.

Minimum Wire Gauge for Extension Cord			
Nameplate Amps	Total Length (in feet)		
	0 – 25	26 – 50	51 – 100
0 – 6	18 AWG	16 AWG	16 AWG
6 – 10	18 AWG	16 AWG	14 AWG
10 – 12	16 AWG	16 AWG	14 AWG
12 – 16	14 AWG	12 AWG	NOT RECOMMENDED

- **Before using, test the Ground Fault Circuit Interrupter (GFCI) provided with the power cord to insure it is operating correctly.** GFCI reduces the risk of electrical shock.
- **Extension cords are not recommended unless they are plugged into a Ground Fault Circuit Interrupter (GFCI) found in circuit boxes or receptacles.** The GFCI on the machine power cord will not prevent electrical shock from the extension cords.
- **Keep all electrical connections dry and off the ground. Do not touch plug with wet hands.** Reduces the risk of electrical shock.

Personal Safety

- **Stay alert, watch what you are doing and use common sense when operating a power tool. Do not use tool while tired or under the influence of drugs, alcohol, or medications.** A moment of inattention while operating power tools may result in serious personal injury.
- **Dress properly. Do not wear loose clothing or jewelry. Contain long hair. Keep your hair, clothing, and gloves away from moving parts.** Loose clothes, jewelry, or long hair can be caught in moving parts.
- **Avoid accidental starting. Be sure switch is OFF before plugging in.** Carrying tools with your finger on the switch or plugging tools in that have the switch **ON** invites accidents.

- **Remove adjusting keys or wrenches before turning the tool ON.** A wrench or a key that is left attached to a rotating part of the tool may result in personal injury.
- **Do not over-reach. Keep proper footing and balance at all times.** Proper footing and balance enables better control of the tool in unexpected situations.
- **Use safety equipment. Always wear eye protection.** Dust mask, non-skid safety shoes, hard hat, or hearing protection must be used for appropriate conditions.

Tool Use and Care

- **Use clamp or other practical way to secure and support the workpiece to a stable platform.** Holding the work by hand or against your body is unstable and may lead to loss of control.
- **Do not force tool. Use the correct tool for your application.** The correct tool will do the job better and safer at the rate for which it is designed.
- **Do not use tool if switch does not turn it ON or OFF.** Any tool that cannot be controlled with the switch is dangerous and must be repaired.
- **Disconnect the plug from the power source before making any adjustments, changing accessories, or storing the tool.** Such preventive safety measures reduce the risk of starting the tool accidentally.
- **Store idle tools out of the reach of children and other untrained persons.** Tools are dangerous in the hands of untrained users.
- **Maintain tools with care. Keep cutting tools sharp and clean.** Properly maintained tools with sharp cutting edges are less likely to bind and are easier to control.
- **Check for misalignment or binding of moving parts, breakage of parts, and any other condition that may affect the tool's operation. If damaged, have the tool serviced before using.** Many accidents are caused by poorly maintained tools.
- **Use only accessories that are recommended by the manufacturer for your model.** Accessories that may be suitable for one tool may become hazardous when used on another tool.
- **Keep handles dry and clean; free from oil and grease.** Allows for better control of the tool.

Service

- **Tool service must be performed only by qualified repair personnel.** Service or maintenance performed by unqualified repair personnel could result in injury.

- **When servicing a tool, use only identical replacement parts. Follow instructions in the Maintenance Section of this manual.** Use of unauthorized parts or failure to follow maintenance instructions may create a risk of electrical shock or injury.

Specific Safety Information

▲ WARNING

Read this operator's manual carefully before using the K-75/K-1500 Drain Cleaners. Failure to understand and follow the contents of this manual may result in electrical shock, fire and/or serious personal injury.

Drain Cleaner Safety

- **Wear leather mitt provided with the machine. Never grasp a rotating cable with a rag or loose fitting cloth glove.** It could get wrapped around the cable and cause serious injury.
- **Do not overstress cables. Keep one hand on the cable for control when the machine is running.** Overstressing cables because of obstruction may cause twisting or kinking or breaking of the cable and result in serious injury.
- **Position machine within two feet of inlet. Use Front End Guide Hose when it is difficult to locate the machine near the access or clean out.** Greater distances can result in cable twisting or kinking.
- **Do not operate machine in (REV) reverse.** Operating machine in reverse can result in cable damage and is used only to back tool out of an obstruction.
- **Operate machine from the side with the FOR/OFF/-REV Switch.** Allows for better control of the machine.
- **Use Rear Guide Hose.** Prevents cable from whipping and picking up debris.
- **Never operate machine with belt guard removed.** Fingers can be caught between the belt and pulley.
- **Be careful when cleaning drains where cleaning compounds have been used. Avoid direct contact with skin and eyes.** Serious burns can result from some drain cleaning compounds.
- **Do not operate machine if operator or machine is standing in water.** Will increase the risk of electrical shock.

- **Wear safety glasses and rubber soled, non-slip shoes.** Use of this safety equipment may prevent serious injury.
- **Only use the K-75 to clean drain lines up to 4" in diameter and the K-1500 machine up to 10" in diameter. Follow instructions on the use of the machine.** Other uses or modifying the drain cleaner for other applications may increase the risk of injury.

Description, Specifications and Standard Equipment

Description

The RIDGID/Kollmann K-75A/B, K-1500A/B & K-1500SP Drain Cleaning Machines are for cleaning 1 1/4" through 10" lines. These machines are driven by induction motors that have a grounded electrical system. An integral Ground Fault Interrupter (GFCI) is built into the line cord. A toggle or rotary switch provides FORWARD/OFF/REVERSE control of the motor.

Machines are designed to use sectional-type cable that has a quick coupling system for disconnecting tools. The cable is manually fed in and out of the machine and rotates at a cable speed of 600 to 700 RPM. The rotation of the cable is controlled by a clutch handle. The cable stops instantly when the clutch handle is released.

K-75 machines come equipped to run 7/8" cable to clean 2" – 4" lines through 175'. They can be adapted to use 5/8" cable to clean 1 1/4" to 3" lines.

K-1500 machines come equipped to run 1 1/4" cable to clean 3" – 10" lines through 200' – the 1500SP through 300'. They can be easily adapted to use 7/8" cable to clean 2" – 4" lines.

Specifications

Line Capacity Depends on choice of cable. Refer to the chart for recommendations

Motor:

K-75A/B

Type.....115V/60Hz, Reversible
 Rating 1/2 HP
 Amps.....7.2

K-1500A/B

Type.....115V/60Hz, Reversible, 230V-240V/50Hz Versions Available Upon Request
 Rating 3/4 HP
 Amps.....10.4

K-1500A/B-SP

Type.....115V/240V/50-60Hz, Reversible, Total Enclosed Fan Cooled
 Rating1 HP
 Amps.....15

Frame:

A Style.....2 Wheels In Rear w/Upright Handle On Frame Assembly and Cable Storage Capacity
 B Style2 Wheels In Front On Frame Assembly.

See the RIDGID RT Catalog for machine model options and accessories. Every machine model includes as standard equipment:

- A-1 Operator's Mitt
- A-12 Pin Key
- A-34-12 Rear Guide Hose

Chart 1

Model No.	Frame Style	Cable Size	Capacity		Horsepower	Overall Height	Width	Length	Machine Wt. Lbs.
			Line	Reach					
K-75A K-75A-SE	A	5/8" or	1 1/4" - 3"	125'	1/2 HP at 640 RPM	41 1/2"	20 3/4"	16"	88
K-75B K-75B-SE	B	7/8"	2" - 4"	175'		27 3/4"	20 3/4"	40 5/8"	76
K-1500A K-1500A-SE	A	7/8" or	2" - 4"	175'	3/4 HP at 710 RPM	41 1/2"	20 3/4"	16"	92
K-1500B K-1500B-SE	B	1 1/4"	3" - 10"	200'		27 3/4"	20 3/4"	40 5/8"	80
K-1500SP K-1500SPA	B A	7/8" 1 1/4"	2" - 4" 3" - 10"	175' 300'	1HP at 600 RPM	27 3/4" 41 1/2"	20 3/4" 20 3/4"	40 5/8" 16"	110 138

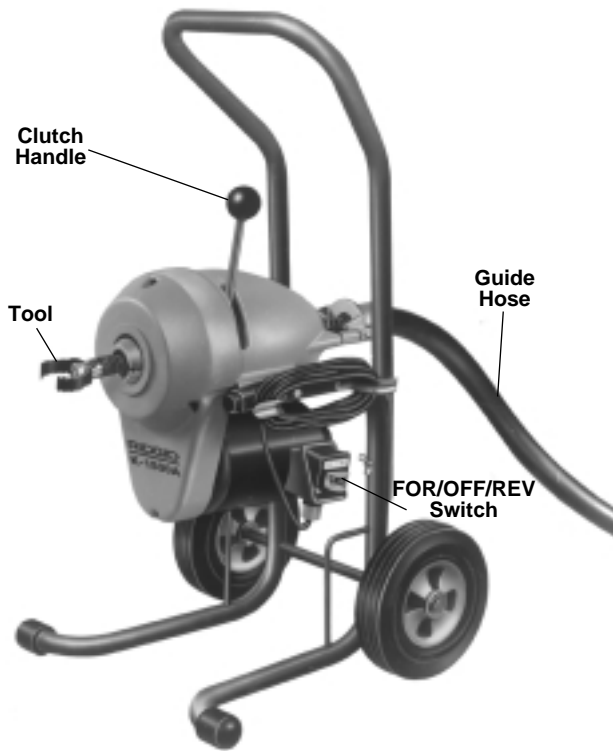

Figure 1 – K-75A, K-1500A and K-1500SPA Drain Cleaners

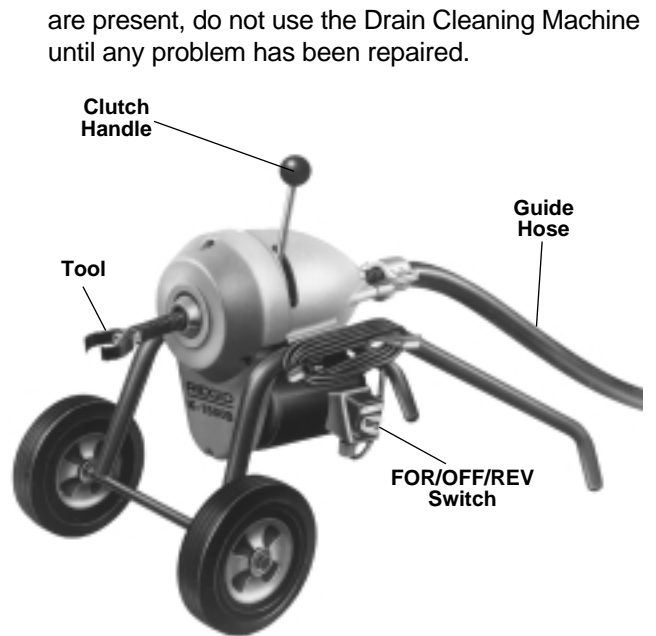
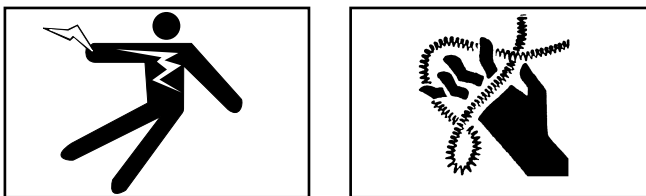

Figure 2 – K-75B, K-1500B and K-1500SP Drain Cleaning Machines

Machine Inspection

▲ WARNING



To prevent serious injury, inspect your Drain Cleaning Machine. The following inspection procedures should be performed before each use.

1. Make sure the Drain Cleaning Machine is unplugged and the directional switch is set to the **OFF** position (Figures 1 and 2).
2. Inspect the power cord, Ground Fault Circuit Interrupter (GFCI) and plug for damage. If the plug has been modified, is missing the grounding prong or if the cord is damaged, do not use the Drain Cleaning Machine until the cord has been replaced.
3. Inspect the Drain Cleaning Machine for any broken, missing, misaligned or binding parts as well as any other conditions which may affect the safe and normal operation of the machine. If any of these conditions

are present, do not use the Drain Cleaning Machine until any problem has been repaired.

4. Lubricate the Drain Cleaning Machine, if necessary, according to the Maintenance Instructions.
5. Use tools and accessories that are designed for your drain cleaner and meet the needs of your application. The correct tools and accessories allow you to do the job successfully and safely. Accessories suitable for use with other equipment may be hazardous when used with this drain cleaner.
6. Clean any oil, grease or dirt from all equipment handles and controls. This reduces the risk of injury due to a tool or control slipping from your grip.
7. Inspect the cutting edges of your tools. If necessary, have them sharpened or replaced prior to using the Drain Cleaning Machine. Dull or damaged cutting tools can lead to binding and cable breakage.
8. Inspect cables and couplings for wear and damage. Cables should be replaced when they become severely worn or corroded. A worn cable can be identified when the outside coils become flat.

▲ WARNING Worn or damaged cables can break causing serious injury.



Machine Set-Up

▲ WARNING

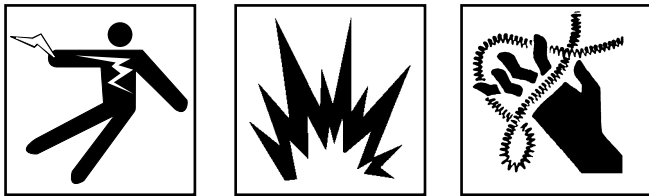

Do not place machine in water. Water entering the motor can result in electrical shock.

To prevent serious injury, proper set-up of the machine and work area is required. The following procedures should be followed to set-up the machine:

1. Check work area for:
 - Adequate lighting
 - Grounded electrical outlet
 - Clear path to the electrical outlet that does not contain any sources of heat or oil, sharp edges or moving parts that may damage electrical cord.
 - Dry place for machine and operator. Do not place the machine in water.
 - Flammable liquids, vapors or dust that may ignite.
2. Position the Drain Cleaning Machine within 2' of sewer inlet. Greater distance can result in cable twisting or kinking.
3. Make sure FOR/OFF/REV switch is in the **OFF** position.



Figure 3 – Rear Guide Hose Attachment

4. Attach the rear guide hose by sliding guide hose adapter onto the guide hose pins (*Figure 3*).

▲ WARNING Do not use machine without rear guide hose attached. Prevents cable whipping, possible entanglement and a cleaner jobsite.

5. Insert first cable into front of machine (female end first) and push through guide hose until approximately one foot remains out the front of the machine (*Figure 4*).



Figure 4 – Inserting Cable Into Front Of Machine

▲ WARNING Never couple more than one cable at a time. Cable will extend behind rear guide tube.

6. Select and install the proper tool to the end of the cable. The T-Slot Coupler allows the tool to be snapped into the cable coupler (*Figure 5*). To remove tool, use the pin key to depress the plunger and slide the coupling apart.

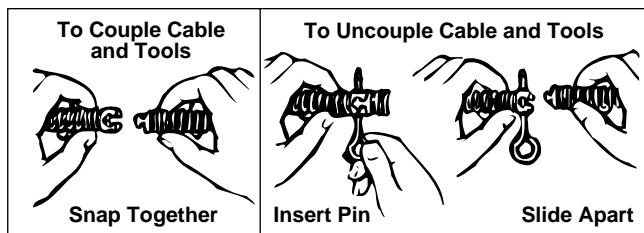

Figure 5 – Coupling and Uncoupling Tools

NOTE! Proper Tool Selection

A good rule of thumb is to use a tool at least 1" smaller than the line to be cleaned. The style of the tool is determined by the nature of the job and is left up to the operator.

7. Plug the Drain Cleaning Machine into the electrical outlet, making sure to position the power cord along the clear path selected earlier. If the power cord does not reach the outlet, use an extension cord in good condition.

▲ WARNING To avoid electric shock and electrical fires, never use an extension cord that is damaged or does not meet the following requirements:

- The cord has a three-prong plug similar to shown in Electrical Safety section.

- The cord is rated as “W” or “W-A” if being used outdoors.
- The cord has sufficient wire thickness (14 AWG - 50'). If the wire thickness is too small, the cord may overheat, melting the cord's insulation or causing nearby objects to ignite.

⚠ WARNING To reduce risk of electrical shock, keep all electrical connections dry and off the ground. Do not touch plug with wet hands. Test the Ground Fault Circuit Interrupter (GFCI) provided with the electric cord to insure it is operating correctly. When test button is pushed in, the indicator light should go off. Reactivate by pushing the reset button in. If indicator light goes on, the machine is ready to use. If the GFCI does not function correctly, do not use the machine.

Operating Instructions

⚠ WARNING

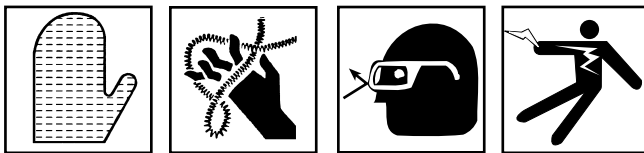

Wear mitts with rivets provided with machine. Never grasp a rotating cable with a rag, loose fitting cloth or leather glove that may become wrapped around the cable causing serious injury.

Always wear eye protection to protect your eyes against dirt and other foreign objects. Wear rubber soled, non-slip shoes.

Be very careful when cleaning drains where cleaning compounds have been used. Wear gloves when handling cable and avoid direct contact to the skin and especially the eyes and facial area as serious burns can result.

Do not operate if clutch handle is damaged or does not function properly. Clutch is a safety feature designed to stop rotation of cable when released.

CAUTION It is important to know approximate distance from inlet to main sewer or septic tank. Over-running cable too far into main sewer or septic tank can cause cables to knot up and prevent their return through small lines. If main is 12 inches or larger and standard 1 1/4" cable is being used, do not allow more than 10 to 15 feet of overrun. When working into a septic tank do not allow more than 3 to 5 feet overrun.

1. Assume the correct operating posture in order to maintain proper balance (Figure 6).

⚠ WARNING Should an unexpected situation arise, this posture provides you with the opportunity to safely keep control of the machine and cable.

- Be sure you can quickly release the clutch handle.

- Hand must be on the cable to control its twisting action when it hits an obstruction.
- Must have access to FOR/OFF/REVERSE switch.



Figure 6 – Proper Operating Position

2. Pull sufficient cable out of the machine to start tool and cable into the sewer inlet. Push cable into inlet as far as it will go.
3. Pull enough extra cable through machine to form almost a half circle between machine and line opening.
4. Hold cable loosely in mitted hand. Put FOR/OFF/REVERSE/ switch in FOR (forward) position.

NOTE! The motor will start but cable will not rotate.

5. With mitted hand on cable, push down on clutch handle with opposite hand to engage cable. Push down on top of the cable loop with a definite snap to advance the cable.

NOTE! A slow or gradual engaging of the clutch handle causes excessive wear of the jaw set. The clutch is instant-acting and returning clutch handle to its original position frees cable instantly.

6. As soon as excess cable has gone into line, release clutch handle and pull six to ten inches of cable out of machine with mitted hand.
7. Continue to feed the cable into the line until resistance or obstruction is encountered. This will become apparent to operator as it will be difficult to feed additional cable into line and/or the cable will have a tendency to twist sideways in operator's hands.

8. If cable loads down in the obstruction, relieve load by pulling back on cable with short, quick jerks to free cutter. Slowly advance cable back into the obstruction. Repeat this process until the obstruction is clear. Remember, make sure the cutter is rotating at all times and never force the cable. At this point, progress depends upon the sharpness of the tool and nature of the obstruction.

▲ WARNING

Do not allow tension to build up in the cable. This will happen if the cutting tool hits a snag and stops turning, but the motor and cable continue to rotate. Torque builds until the cable suddenly twists, potentially wrapping around your hand or arm. This can happen quickly and without warning, so proceed slowly and carefully as you feed the cable into the drain. Releasing clutch handle will stop the cable rotating and releases the torque. If tool gets hung up in an obstruction, refer to Reverse Operating Instructions in the "Special Procedures" section.

9. Once obstruction is cleared, it is recommended that operator flush debris from line with running water. Repeat Step 8 several times if necessary for thorough cleaning job and then work cable through additional stoppages as required.

10. To add cable, the following procedure should be followed:

- After reaching the end of each cable section, turn the machine OFF.
- Secure the cable by looping it in the line (Figure 7). This procedure is especially useful when cleaning a line with a steep grade.

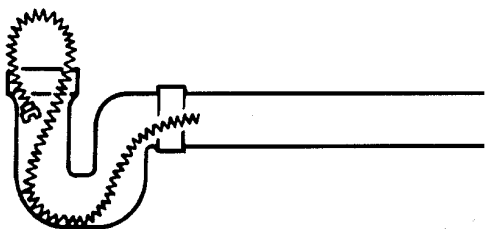

Figure 7 – Looping Cable In Line

- With line secured, insert another section of cable in through the front of the machine (female end first) until approximately one foot remains out the front of the machine.
 - Attach cable to cable in line and resume operation.
11. To retrieve cable from drain line, the following procedure should be followed:
- Leave FOR/OFF/REV switch in FOR (forward) position.

- Push down on clutch handle to engage cable. With mitted hand pull cable out of line (if possible) or hold cable against edge of inlet to thread the cable out until loop forms in front of the machine.

NOTE! By holding the cable against the edge of the inlet, the rotation will rapidly "thread" the cable out of the line.

- When loop forms, release clutch handle and push excess cable back through machine. Disconnect one section at a time.

▲ WARNING When disconnecting sections, remember to turn unit off and secure cable in line.

- Once section of cable is removed, insert the secured cable in through the front of the machine and continue removing sections until tool on last section of cable is just inside sewer inlet.

HINT! When placing removed cables back into cable carrier, reconnect all cables. This assures easy removal at next job.

▲ WARNING Never retract tool from sewer inlet while cable is rotating. Tool can whip causing serious injury.

12. Turn FOR/OFF/REV Switch to OFF position.
13. Pull remaining cable and tool from sewer.
14. Unplug power cord and remove guide hose.

CAUTION After using, thoroughly flush and drain cables, couplings and tools with water due to damaging effects of some drain cleaning compounds.

Special Procedures

Reverse Operation

Running machine in reverse will cause premature failure of cable. Use reverse only to free a tool or cable caught in an obstruction. If this should occur, immediately release clutch handle and place FOR/OFF/REV switch to OFF position. After motor comes to a complete stop, place FOR/OFF/REV switch in the REV (reverse) direction. Engage clutch handle only until cable or tool is free of obstruction. Once it is free, release clutch handle immediately. Turn unit OFF. Run unit in FOR (forward) direction and follow normal operating procedure.

▲ WARNING Never operate this machine in REV (reverse) for any other purpose. Operating in reverse can damage a cable and cause serious injury.

Cable Applications

Standard Cable Standard 7/8" or 1 1/4" cable can be used in straight lines from 3" through 6" and through fittings. (Figure 8)

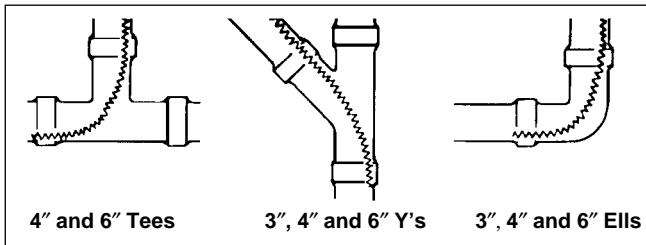

Figure 8 – Standard Cable Application

Heavy-Duty Cable Where conditions allow, heavy-duty 1¼ inch cable, such as C-14, should be used for faster results and longer cable life. The heavy-duty cables work effectively in 4” through 8” straight lines. (Figure 9)

NOTE! This type cable should not be used in areas where 4” “P” traps or 4” running traps are currently in use.

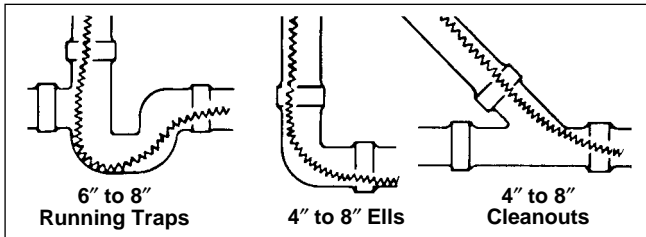

Figure 9 – Heavy Duty Cable Application

Faster Cleaning Obstructions of grease or fats can be cleaned faster and more effectively by bending the cable some 6” or 8” behind the cutter. (Figure 10)

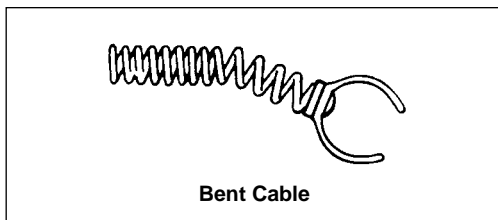

Figure 10 – Bending Cable for Faster Cleaning

Storing And Transporting Cable
 (“A” Frame Models Only)

Cables can be stored and transported on “A” frame models as shown in Figure 11.



Figure 11 – Storing Cables On “A” Frame Models

Accessories

⚠ WARNING Only the following RIDGID/Kollmann products have been designed to function with the Sectional Drain Cleaning Machines. Other accessories suitable for use with other tools may become hazardous when used on the machines. To prevent serious injury, use only the recommended accessories.

K-75A/B Machines

Cables and Leaders

Catalog No.	Model No.	Description
62275	C-10	15’ All-Purpose Wind (4.6m)
30007	T-127	7/8” Trap Leader

5/8” Cables

Catalog No.	Model No.	Description
51317	C-9	10’ Heavy-Duty (3m)
62270	C-8	7½’ All-Purpose Wind (2.3m)
62265	C-7	7½’ Tight-Wind (2.3m)

Accessories

Catalog No.	Model No.	Description
59360	A-3	Tool Box
59205	A-1	Left-Hand Mitt
59295	A-2	Right-Hand Mitt
59225	A-12	Pin Key, 7/8" Cable
59230	A-13	Pin Key, 5/8" Cable
59470	A-8	Cable Carrier (Five Sections/C-10)
59210	A-10	Cable Carrier (Three Sections/C-10)
59425	A-36	Cable Caddy
59330	A-376X	Jawset Adapts K-75 to 5/8" Cable
59325	A-368X	7/8" Replacement Jawset
84315	A-34-8	8' Rear Guide Hose
59415	A-34-10	10' Rear Guide Hose
59395	A-34-12	12' Rear Guide Hose

Tools for C-10 Cable - 7/8"

Catalog No.	Model No.	Description	Replacement Blade(s)
62850	T-101	Straight Auger	—
62855	T-102	Funnel Auger	—
27642	T-125	Retrieving Auger	—
62860	T-103	Sawtooth Cutter, 2 1/2"	98070
62865	T-104	"H" Cutter, 2 1/2"	97800
62870	T-105	Grease Cutter, 2 1/2"	97920
62875	T-106	Grease Cutter, 3 1/2"	97925
62880	T-107	Spade Cutter, 1 3/4"	92850
62915	T-109	Spiral Sawtooth Cutter, 1 3/4"	97930
62920	T-110	Spiral Sawtooth Cutter, 2 1/4"	97935
62925	T-111	Spiral Sawtooth Cutter, 3"	92890
62930	T-112	4-Blade Cutter, 1 3/4"	97915
62935	T-113	4-Blade Cutter, 3"	97940
98050	T-150	Sharktooth Cutter, 3" and 4"	See Below
98055	T-150-1	Sharktooth Cutter, 3" Blade	98005
98060	T-150-2	Sharktooth Cutter, 4" Blade	98010
62940	T-114	Chain Knocker	97985

K-1500A/B Machines

Cables and Leaders

Catalog No.	Model No.	Description
92280	C-11	15' Standard All-Purpose Wind, 3/8" Pitch. Good for 4" Traps, 3" - 8" Lines.
62285	C-12	15' Extra-Heavy-Duty Wind, 3/8" Pitch. 4" - 10" Long Runs, No 4" Traps.
62295	C-14	15' Heavy-Duty Wind, 1/2" Pitch. 3" - 10" Lines Through Cleanout, No 4" Traps.
62300	C-15	15' Extra-Flexible Wind, 1/2" Pitch. 3" - 6" Lines Good for Traps.
63090	T-27	1 1/4" x 25' Leader
62275	C-10	15' Standard All-Purpose Wind, Requires A-368X Jawset 7/8" Tools

Accessories

Catalog No.	Model No.	Description
59470	A-8	Cable Carrier, 60' Capacity (1 1/4")
59210	A-10	Cable Carrier, 150' Capacity (1 1/4")
59415	A-34-10	10' Rear Guide Hose
59395	A-34-12	12' Rear Guide Hose
59400	A-34-16	16' Rear Guide Hose
59300	A-20	8' Front Guide Hose Assembly
59205	A-1	Left-Hand Mitt
59295	A-2	Right-Hand Mitt
59360	A-3	Tool Box
59225	A-12	Coupling Pin Key
59440	A-4	Trap Spoon (30")
59240	A-17	Manhole Guide Pipe
59320	A-369X	1 1/4" Replacement Jawset

Tools for C-11, C-12, C-14 and C-15 Cables 1 1/4"

Catalog No.	Model No.	Description
62840	T-1	Straight Auger
61800	T-2	Heavy-Duty Straight Auger
63105	T-3	Funnel Auger
61790	T-4	Heavy-Duty Funnel Auger
63190	T-5	Straight Retrieving Auger
63195	T-6	Funnel Retrieving Auger
63200	T-7	Hook Auger
63205	T-8	Grease Cutter, 2 1/2"
63210	T-9	Grease Cutter, 3 1/2"
62845	T-10	Grease Cutter, 4 1/2"
59480	T-11	"H" Cutter, 2 1/2"
59485	T-12	"H" Cutter, 3 1/2"
61970	T-13	Sawtooth Cutter, 2 1/2"
61975	T-14	Sawtooth Cutter, 3 1/2"
61770	T-15A	Expanding Cutter, 4" - 6"
61825	T-15B	Expanding Cutter, 6" - 8"
61960	T-16	Spiral Bar Cutter, 4"
61850	T-17	Spiral Bar Cutter, 6"
61855	T-18	Spiral Bar Cutter, 8"
59625	T-21	Spiral Sawtooth Cutter, 3 1/2"
63075	T-22	Spiral Sawtooth Cutter, 3"
63085	T-23	Spiral Sawtooth Cutter, 4"
59765	T-24	4-Blade Cutter, 2 1/2"
59770	T-25	4-Blade Cutter, 3 1/2"
59775	T-26	4-Blade Cutter, 4 1/2"
59780	T-26A	4-Blade Cutter, 5 1/2"
98030	T-50	Three Blade, 3" - 4" - 5"
98035	T-50-1	Sharktooth Cutter, 3"
98040	T-50-2	Sharktooth Cutter, 4"
98045	T-50-3	Sharktooth Cutter, 6"
63110	T-31	Chain Knocker, 3" - 4" Pipe
63115	T-32	Chain Knocker, 6" Pipe
63120	T-33	Chain Knocker, 8" Pipe
63145	T-38	Flue Brush, 1 1/2"
63150	T-39	Flue Brush, 2"
63155	T-40	Flue Brush, 2 1/2"
63160	T-41	Flue Brush, 3"
63165	T-42	Flue Brush, 3 1/2"
63170	T-43	Flue Brush, 4"
63175	T-44	Flue Brush, 4 1/2"
63240	T-45	Flue Brush, 5"
63180	T-46	Flue Brush, 5 1/2"
63185	T-47	Flue Brush, 6"

NOTE! See Ridge Tool Catalog for complete list of tools and accessories.



Maintenance Instructions

▲ WARNING

Make sure machine is unplugged from power source before performing maintenance or making any adjustment.

Moving Parts Lubrication

Grease all exposed moving parts such as rocker arms and main bearing approximately every three months. Make sure to grease main bearing thru grease fitting inside clutch handle slot.

Clutch Jaws Lubrication

Clean and lubricate clutch driver jaws with oil after each use.

Cables

Cables should be thoroughly flushed with water to prevent damaging effects of sediment and drain cleaning compounds. Periodically lubricate cables and couplings with RIDGID/Kollmann Cable Rust Inhibitor.

When not in use, store cables indoors to prevent deterioration by the elements.

Cables should be replaced when they become severely corroded or worn. A worn cable can be identified when outside coils of cable become flat.

Clutch Jaws Replacement

1. Remove four screws holding the front guard to the housing.
2. Remove screws from the nose piece assembly (Figure 12).

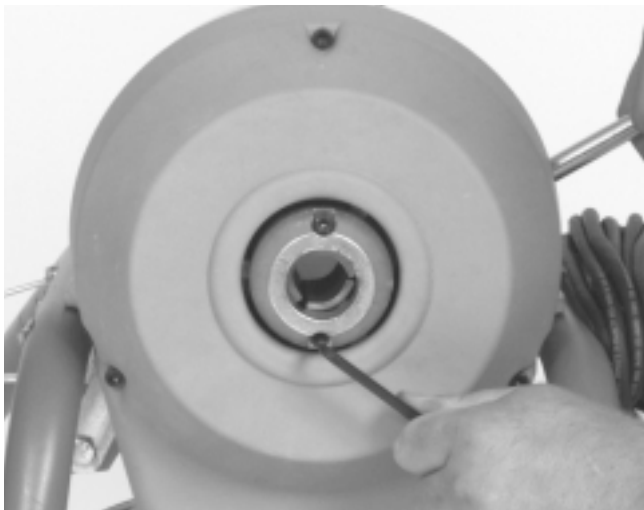

Figure 12 – Replacing Clutch Jaws

3. Slide out clutch driver jaws and replace with desired size jaws.

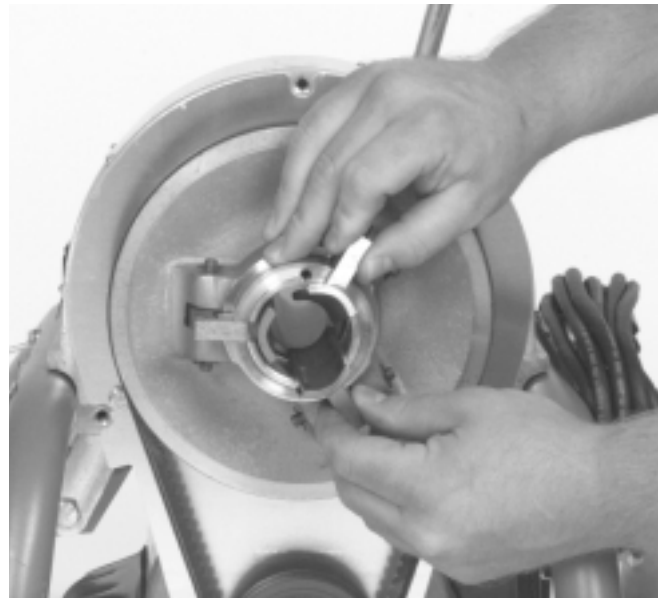

Figure 13 – Replacing Clutch Jaws

4. Replace nose piece assembly, screws and guard.

▲ WARNING Never operate machine with belt guard removed. Fingers can be caught between the belt and pulley.

Removing Clutch End Play

1. To remove end play from clutch, loosen screw in Adjusting Nut. (Figure 14).
2. Turn lock and adjusting nut clockwise until snug against housing, then *back off* one half turn.
3. Tighten screw in lock and adjusting nut.



Figure 14 – Removing Clutch End Play

V-Belt Adjustment

Check V-Belt periodically for loosening. V-Belt should be kept tight at all times.

1. To tighten V-Belt remove Guard.
2. Loosen locknut, turn adjusting bolt slowly until V-Belt stiffens, tighten locknut. (Figure 15).

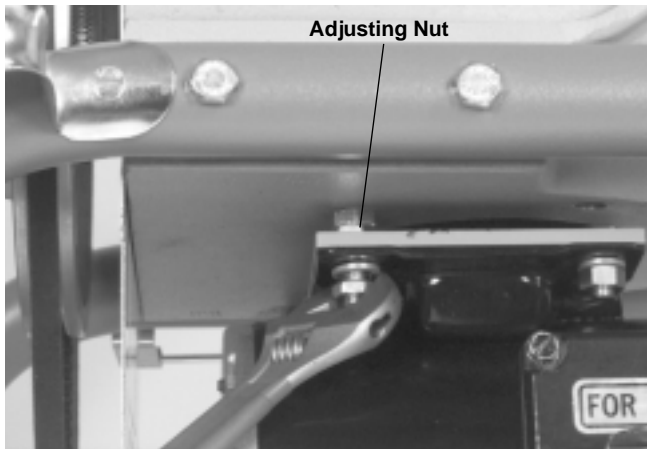

Figure 15 – Adjusting V-Belt Tension

Machine Storage

⚠ WARNING Motor-driven equipment must be kept indoors or well covered in rainy weather. Store the machine in a locked area that is out of reach of children and people unfamiliar with drain cleaners. This machine can cause serious injury in the hands of untrained users.

If machine has been exposed to freezing weather, unit must be run for ten (10) to twenty (20) minutes without load to warm up. Failing to do this will result in frozen bearings. If machine is exposed to weather for a period of time, moisture will form across motor windings causing motor to burn out.

Service and Repair

⚠ WARNING



The “Maintenance Instructions” will take care of most of the service needs of this machine.

⚠ WARNING When servicing this machine, only identical replacement parts should be used. Failure to follow these instructions may create a risk of electrical shock or other serious injury.

K-75A/B & K-1500A/B Wiring Diagram

115V

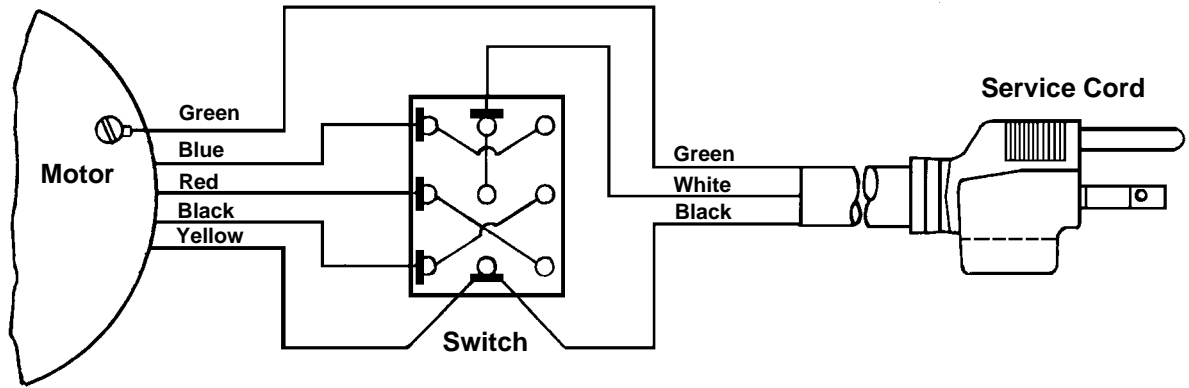

K-1500SP Wiring Diagram

120V/60 Hz

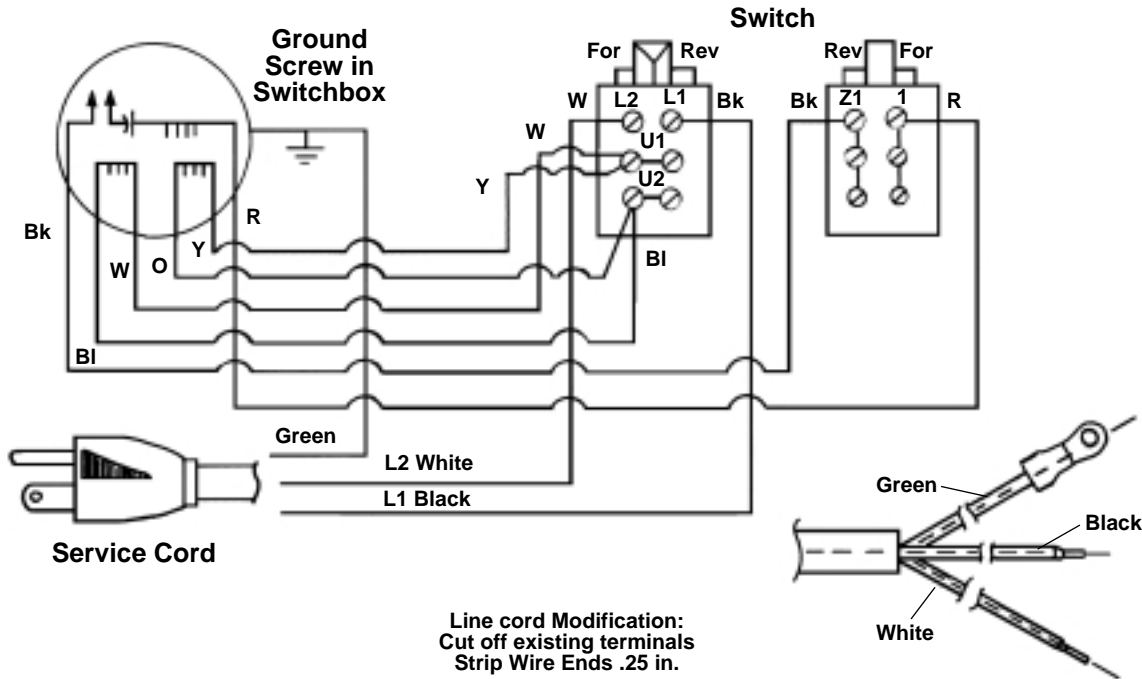

K-1500SP Wiring Diagram

220-240V/50 Hz

