

R18, R19, R18SP



Gas
Distribution



Water
Management

Three-piece fittings

Datasheet
0568EN 11/2019



R18







R19

Three-piece straight R18 or elbow fittings R19, chrome plated or brass finished, with female-tail piece male threaded connections.

Suitable for use in plumbing, gas distribution and solar thermal systems.

➤ Versions and product codes

PRODUCT CODE	CONNECTIONS	TYPE
R18Y002	G 3/8" F x G 3/8" M	 Brass finish
R18Y003	G 1/2" F x G 1/2" M	
R18Y004	G 3/4" F x G 3/4" M	
R18Y005	G 1" F x G 1" M	
R18Y006	G 1-1/4" F x G 1-1/4" M	
R18Y017	G 1-1/2" F x G 1-1/2" M	
R18Y018	G 2" F x G 2" M	
R18Y007	Rc 1-1/2" x R 1-1/2"	
R18Y008	Rc 2" x R 2"	
R18Y063	Rp 1/2" x R 1/2"	
R18Y064	Rp 3/4" x R 3/4"	
R18Y065	Rp 1" x R 1"	
R18X002	G 3/8" F x G 3/8" M	
R18X003	G 1/2" F x G 1/2" M	
R18X004	G 3/4" F x G 3/4" M	
R18X005	G 1" F x G 1" M	
R18X006	G 1-1/4" F x G 1-1/4" M	
R18X017	G 1-1/2" F x G 1-1/2" M	
R18X018	G 2" F x G 2" M	
R18X007	Rc 1-1/2" x R 1-1/2"	
R18X008	Rc 2" x R 2"	

PRODUCT CODE	CONNECTIONS	TYPE
R19Y002	G 3/8" F x G 3/8" M	 Brass finish
R19Y003	G 1/2" F x G 1/2" M	
R19Y004	G 3/4" F x G 3/4" M	
R19Y005	G 1" F x G 1" M	
R19Y006	G 1-1/4" F x G 1-1/4" M	
R19Y017	G 1-1/2" F x G 1-1/2" M	
R19Y018	G 2" F x G 2" M	
R19Y007	Rc 1-1/2" x R 1-1/2"	
R19Y008	Rc 2" x R 2"	
R19Y063	Rp 1/2" x R 1/2"	
R19Y064	Rp 3/4" x R 3/4"	
R19Y065	Rp 1" x R 1"	
R19X002	G 3/8" F x G 3/8" M	
R19X003	G 1/2" F x G 1/2" M	
R19X004	G 3/4" F x G 3/4" M	
R19X005	G 1" F x G 1" M	
R19X006	G 1-1/4" F x G 1-1/4" M	
R19X017	G 1-1/2" F x G 1-1/2" M	
R19X018	G 2" F x G 2" M	
R19X007	Rc 1-1/2" x R 1-1/2"	
R19X008	Rc 2" x R 2"	

Technical data

Plumbing systems

- Suitable for use in plumbing HVAC systems, domestic water systems and solar thermal systems
- Temperature range: 5+160 °C for size 3/8", 1/2", 3/4", 1", 1-1/4"
5+110 °C for size 1-1/2", 2"
- Max. working pressure: 10 bar

Gas distribution systems

-  Fittings R18Y063, R18Y064, R18Y065, R19Y063, R19Y064 and R19Y065 comply with regulation UNI 7129 for gas distribution and they feature threading which complies with EN 10226
- Temperature range: 5+90 °C
- Max. working pressure: 5 bar (MOP 5)

Materials

- Fitting: brass UNI EN 12165 CW617N
- Sealing element: PTFE gasket for size 3/8", 1/2", 3/4", 1", 1-1/4"
NBR O-Ring for size 1-1/2", 2"

NOTE. The system must be seal tested before being commissioned, according to the indications outlined in the current legislation and relative technical Standards, and in particular for use with gas according to the requirements stipulated in Chapter 5, 7129-1: 2008 UNI.

Dimensions

R18

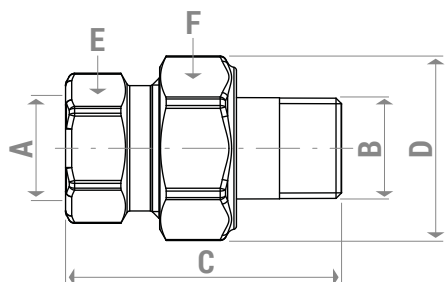

CONNECTIONS A x B	C [mm]	D [mm]	E [mm]	F [mm]
G 3/8"F x G 3/8"M	45	30	ch.22	ch.27
G 1/2"F x G 1/2"M Rp 1/2" x R 1/2"	49	33	ch.26	ch.30
G 3/4"F x G 3/4"M Rp 3/4" x R 3/4"	53	42	ch.32	ch.38
G 1"F x G 1"M Rp 1" x R 1"	58	51	ch.39	ch.46
G 1-1/4"F x G 1-1/4"M	64	59	ch.49	ch.53
G 1-1/2"F x G 1-1/2"M	90	73	ch.55	ch.65
G 2"F x G 2"M	100	87	ch.67	ch.82
Rc 1-1/2" x R 1-1/2"	92	73	ch.55	ch.65
Rc 2" x R 2"	104	87	ch.67	ch.82

R19

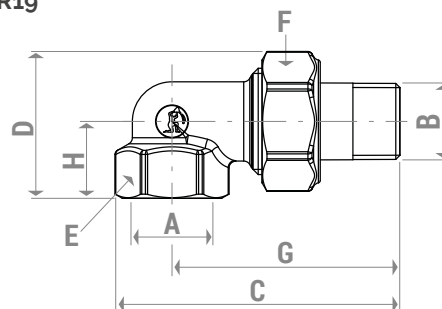

CONNECTIONS A x B	C [mm]	D [mm]	E [mm]	F [mm]	G [mm]	H [mm]
G 3/8"F x G 3/8"M	61	32	ch.22	ch.27	50	17
G 1/2"F x G 1/2"M Rp 1/2" x R 1/2"	67	36	ch.26	ch.30	53	19
G 3/4"F x G 3/4"M Rp 3/4" x R 3/4"	81	44	ch.32	ch.38	63	23
G 1"F x G 1"M Rp 1" x R 1"	87	60	ch.39	ch.46	65	35
G 1-1/4"F x G 1-1/4"M	107	72	ch.49	ch.53	80	43
G 1-1/2"F x G 1-1/2"M	130	84	ch.55	ch.65	100	48
G 2"F x G 2"M	149	101	ch.67	ch.82	112	58
Rc 1-1/2" x R 1-1/2"	132	84	ch.55	ch.65	102	48
Rc 2" x R 2"	153	101	ch.67	ch.82	116	58



R18SP

Three-piece straight fittings with flat seat R18SP, brass finished, with female-tail piece male threaded connections. Suitable for use in plumbing systems.

➤ Versions and product codes

PRODUCT CODE	CONNECTIONS	TYPE
R18SPY005	G 1"F x G 1"M	Brass finish 
R18SPY006	G 1-1/4"F x G 1-1/4"M	
R18SPY007	Rc 1-1/2" x R 1-1/2"	
R18SPY008	Rc 2" x R 2"	

➤ Technical data

Plumbing systems

- Suitable for use in plumbing HVAC systems and domestic water systems
- Temperature range: 5÷110 °C
- Max. working pressure: 10 bar

Materials

- Fitting: brass UNI EN 12165 CW617N
- Gasket: EPDM

NOTE. The system must be seal tested before being commissioned, according to the indications outlined in the current legislation and relative technical Standards.

➤ Dimensions

R18SP

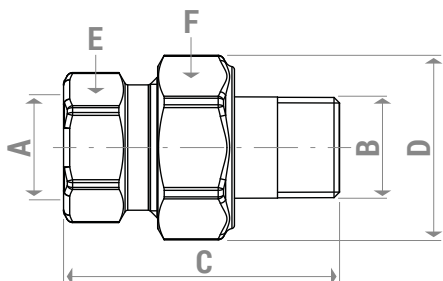

CONNECTIONS A x B	C [mm]	D [mm]	E [mm]	F [mm]
G 1"F x G 1"M	58	51	ch.39	ch.46
G 1-1/4"F x G 1-1/4"M	64	59	ch.49	ch.53
Rc 1-1/2" x R 1-1/2"	93	73	ch.55	ch.65
Rc 2" x R 2"	104	87	ch.67	ch.82

Product specifications

R18

Three-piece straight fittings, with female-tail piece male threaded connections. Made of brass UNI EN 12165 CW617N chrome plated or brass finish. Suitable for use in plumbing, gas distribution and solar thermal systems. Gasket in PTFE for size 3/8", 1/2", 3/4", 1", 1-1/4"; O-Ring in NBR for size 1-1/2", 2". Temperature range for plumbing systems 5÷160 °C for size 3/8", 1/2", 3/4", 1", 1-1/4"; 5÷110 °C for size 1-1/2", 2". Temperature range for gas distribution systems 5÷90 °C. Max. working pressure for plumbing systems 10 bar. Max. working pressure for gas distribution systems 5 bar (MOP 5).

R19

Three-piece 90° elbow fittings, with female-tail piece male threaded connections. Made of brass UNI EN 12165 CW617N chrome plated or brass finish. Suitable for use in plumbing, gas distribution and solar thermal systems. Gasket in PTFE for size 3/8", 1/2", 3/4", 1", 1-1/4"; O-Ring in NBR for size 1-1/2", 2". Temperature range for plumbing systems 5÷160 °C for size 3/8", 1/2", 3/4", 1", 1-1/4"; 5÷110 °C for size 1-1/2", 2". Temperature range for gas distribution systems 5÷90 °C. Max. working pressure for plumbing systems 10 bar. Max. working pressure for gas distribution systems 5 bar (MOP 5).

R18SP

Three-piece straight fittings, with flat seat, with female-tail piece male threaded connections. Made of brass UNI EN 12165 CW617N. Suitable for use in plumbing systems. Gasket in EPDM. Temperature range 5÷110 °C. Max. working pressure 10 bar.

 **Safety Warning.** Installation, commissioning and periodical maintenance of the product must be carried out by qualified operators in compliance with national regulations and/or local standards. A qualified installer must take all required measures, including use of Individual Protection Devices, for his and others' safety. An improper installation may damage people, animals or objects towards which Giacomini S.p.A. may not be held liable.

 **Package Disposal.** Carton boxes: paper recycling. Plastic bags and bubble wrap: plastic recycling.

 **Additional information.** For more information, go to giacomini.com or contact our technical assistance service. This document provides only general indications. Giacomini S.p.A. may change at any time, without notice and for technical or commercial reasons, the items included herewith. The information included in this technical sheet do not exempt the user from strictly complying with the rules and good practice standards in force.

 **Product Disposal.** Do not dispose of product as municipal waste at the end of its life cycle. Dispose of product at a special recycling platform managed by local authorities or at retailers providing this type of service.