

SALUS[®] C O N T R O L S

Model: RT310RF



Installation Manual

| | |
|---------------------------------|----|
| Product Compliance | 3 |
| Safety Information | 3 |
| Box Content | 3 |
| Introduction | 4 |
| Features | 5 |
| Installation | 5 |
| Button functions and keys | 7 |
| Installer mode | 9 |
| Operations | 10 |
| Other functions | 12 |
| Factory reset | 13 |
| Technical info | 13 |
| Warranty | 14 |

Product Compliance

This product complies with the essential requirements and other relevant provisions of the following EU Directives: 2014/30/EU, 2014/35/EU, 2014/53/EU and 2011/65/EU. The full text of the EU Declaration of Conformity is available at the following internet address: www.saluslegal.com.

Safety Information

Use in accordance with the EU and national regulations. For indoor use only. Keep your device completely dry. This product must be installed by a competent person and in accordance with all the EU and national regulations.



Always isolate the AC Mains supply before installing or working on any components that require 230 VAC 50Hz supply.

Box content

The box includes the 310RF thermostat, the RT310 receiver (pre paired), 2 AA batteries a set of screws and the Quick Guide installation manual.



RT310RF thermostat



RXRT510 receiver



2xAA batteries and 4x screws



Installation Quick Guide

A room thermostat simply switches the heating system on and off as necessary. It works by sensing the air temperature, switching on the heating when the air temperature falls below the thermostat setting, and switching it off once this set temperature has been reached.

Turning a room thermostat to a higher setting will not make the room heat up any faster. How quickly the room heats up depends on the design of the heating system, for example, the size of boiler and radiators. Neither does the setting affect how quickly the room cools down. Turning a room thermostat to a lower setting will result in the room being controlled at a lower temperature, and saves energy.

The heating system will not work if a time switch or programmer has switched it off.

The way to set and use your room thermostat is to find the lowest temperature setting that you are comfortable with, and then leave it alone to do its job. The best way to do this is to set the room thermostat to a low temperature – say 18°C – and then turn it up by one degree each day until you are comfortable with the temperature.

You won't have to adjust the thermostat further. Any adjustment above this setting will waste energy and cost you more money.

If your heating system is a boiler with radiators, there will usually be only one room thermostat to control the whole house. But you can have different temperatures in individual rooms by installing thermostatic radiator valves (TRVs) on individual radiators. If you don't have TRVs, you should choose a temperature that is reasonable for the whole house. If you do have TRVs, you can choose a slightly higher setting to make sure that even the coldest room is comfortable, then prevent any overheating in other rooms by adjusting the TRVs.

Room thermostats need a free flow of air to sense the temperature, so they must not be covered by curtains or blocked by furniture. Nearby electric fires, televisions, wall or table lamps may prevent the thermostat from working properly.

Features

The RT310RF from SALUS Controls is a stylish and accurate digital thermostat with an easy to read Liquid Crystal Display (LCD).

The Receiver is used for wiring connections and heat on/off control. The thermostat provides the user interface and temperature sensing / control. The two units are linked together by a Radio Frequency (RF) signal.



Features

- Frost protection
- Low-Battery Warning
- Low-Battery Detection
- Modern Casing
- Sleep Mode
- User Friendly
- Pre-Paired in Factory
- RF Test Pairing

Installation

Note: Please insert batteries into the RT310RF thermostat and it will power up..

DIP switch settings

The DIP switches are found on the rear of your thermostat and can be used to change the span (temperature accuracy) of your thermostat from the default $\pm 0.5^{\circ}\text{C}$ to $\pm 0.25^{\circ}\text{C}$. This may cause your boiler to operate more frequently. The DIP switches are located on the back of the thermostat. ON $\pm 0.25^{\circ}\text{C}$, OFF $\pm 0.5^{\circ}\text{C}$. The span is the accuracy with which the thermostat operates when displaying your temperature. You can increase the accuracy by setting the span to $\pm 0.25^{\circ}\text{C}$, meaning that your thermostat will be sensitive to a quarter of a degree temperature change and will activate/deactivate the boiler.



ON

± 0.25

± 0.5

2

Connecting the RXRT510 receiver

Unscrew the backplate of the RXRT510 receiver in order to do the wiring connections. After that please switch the receiver ON.

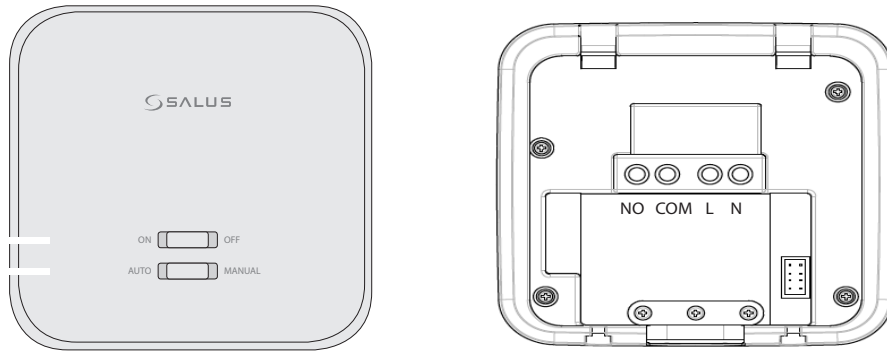

| Terminal | Description | Receiver Terminals |
|----------|------------------------|--------------------|
| NO | Switch Terminal | |
| COM | Common Switch Terminal | |
| L | Mains Live (230VAC) | |
| N | Mains Neutral | |

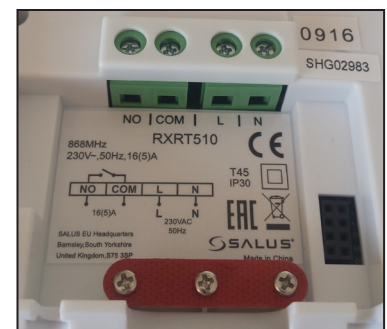

Wiring

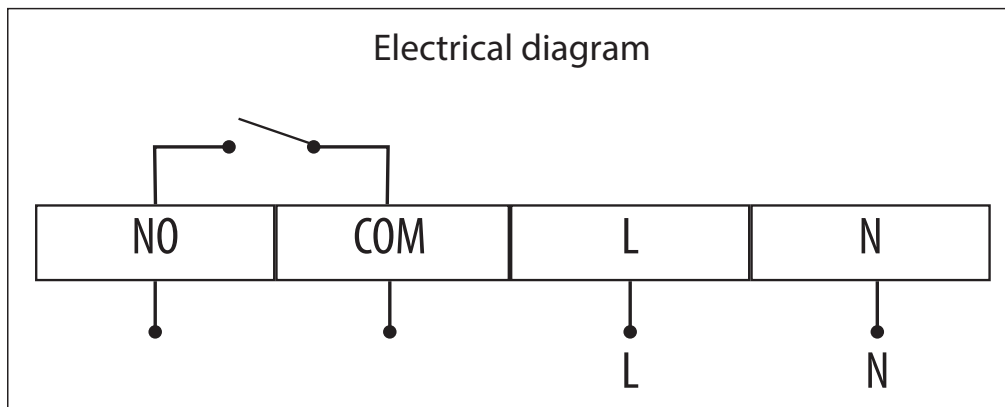

Wall mounting



Fix the backplate to the wall



Align the front housing at the top edge.



Fit the front housing. Press lightly

Button functions and keys

There are few user controls for the RT310RF, making this thermostat very easy to operate. These controls are shown below, along with a description of each of their functions. The temperature displayed on the LCD is the current room temperature. All the LCD icons with a description are shown below.

Thermostat



| Key | Function |
|--------------------|--|
| | Turn on the LCD backlight |
| | Turn On/Off the Frost Mode |
| | Increase button |
| | Decrease button |
| | 1. Press once to enter/exit in RF Test Mode 2. Press for 3 seconds to enter/exit Pairing Mode |
| + + | Press for 3 seconds all the buttons to enter Installer Mode |

Thermostat LCD



| Icon | Meaning |
|------|---|
| | Thermostat is calling for heat |
| | Thermostat is in Frost Protection Mode |
| | Thermostat is paired with the receiver |
| | Low Battery Warning Indicator |
| | Current Temperature/Set Point Temperature |

Receiver

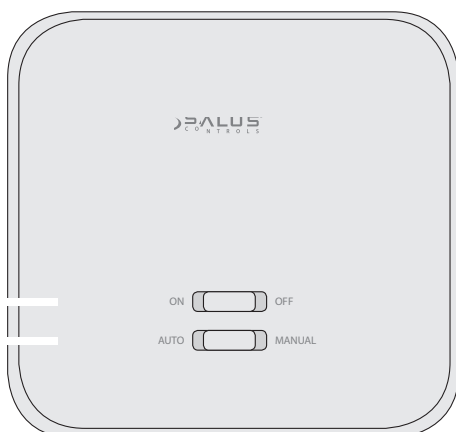

| Key/LED | Function |
|-----------|--|
| AUTO | System receiver output will switch on and off in relation to the command from the RT310RF transmitter. |
| Manual | System receiver output is controlled by the On/Off slide switch. |
| ON | When in Manual Mode, ON will turn on the boiler. |
| OFF | When in Manual Mode, OFF will turn off the boiler. |
| Red Led | Receiver On, paired. |
| Green Led | Command from thermostat received. |

Test Pairing Function

Make sure your devices are wired and the thermostat has batteries inserted. Switch receiver to ON. If you are using the RT310RF pack, the pairing between the thermostat and the receiver is already done. If you bought the RT310TX and RXRT510 separately then pair as follows. Please make sure that the Receiver is set on Auto.

Note: Before beginning the process, switch the receiver On/Off and then On again to reset it (On/Off/On).

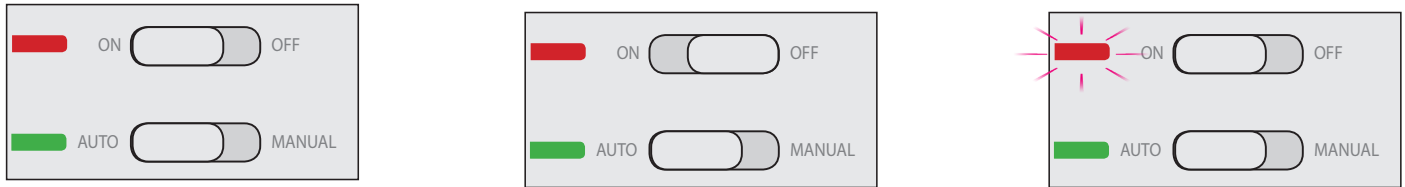

Begin the pairing process

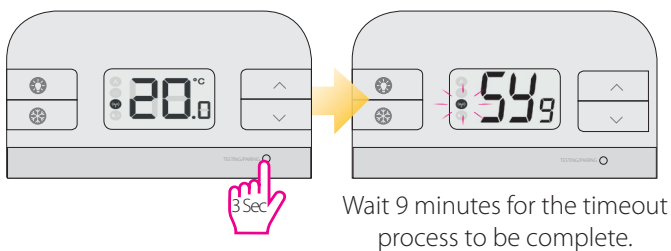

End the pairing process

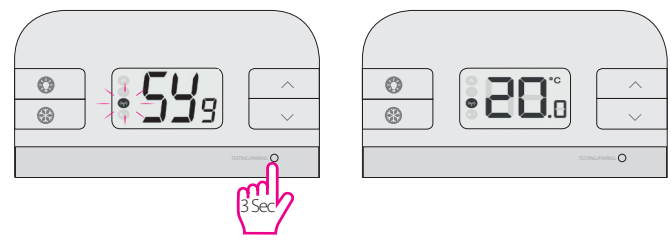

Test the pairing process

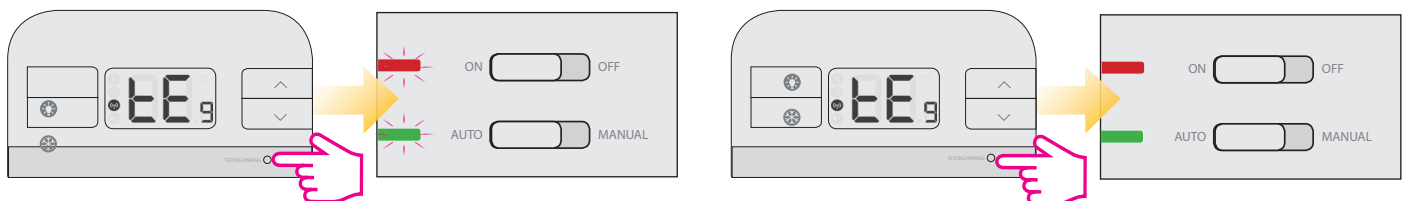











Testing the RF transmissions

It is important to site both the Receiver and thermostat in locations where the RF signal cannot be interrupted. The receiving range between the thermostat and Receiver is approximately 30 metres indoors, however many factors can affect the RF transmission and shorten the operating distance, e.g. shielding by thick walls, foil back plasterboard, metal objects such as filing cabinets, general RF interference, and so on. The range is generally large enough for most household applications, but it is advisable to test the RF transmission from the intended thermostat location to the Receiver location before fixing the thermostat to the wall.

To check the RF reception, follow the following steps:

1. Press the UP button on the thermostat until the set point temperature is higher than room temperature by a few degrees.
2. Wait for a few seconds. The Heat on (heat call) indicator should appear on the bottom left of the LCD on the thermostat.
3. Check the green LED on the receiver unit - it should be lit.
4. Press the DOWN button to adjust the set point temperature to be lower than room temperature.
5. Wait for a few seconds, and the Heat on (heat call) indicator should disappear and the green LED should switch off.
6. If at step 3 the green LED is not illuminated, press the TEST/PAIRING button on the thermostat and try to place the thermostat closer to the Receiver.
7. Repeat steps 1 to 5.

Installer Mode

Press and hold  and  and  keys to enter installation setting. The first setting is temperature display resolution selection - d01. Press  to enter the existing setting. The setting will start flashing. Press  or  to change temperature display resolution, wait for 10 seconds to confirm, then enter d02 (if you didn't press  to save your selection, the change will be confirmed after 10 seconds and the thermostat will return to normal mode). d02 is to set temperature offset, press  or  to increase/decrease offset. To exit Installer Mode don't press any key for 10 seconds, or press .

See the table below.

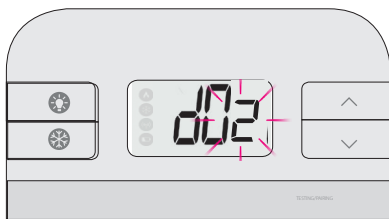
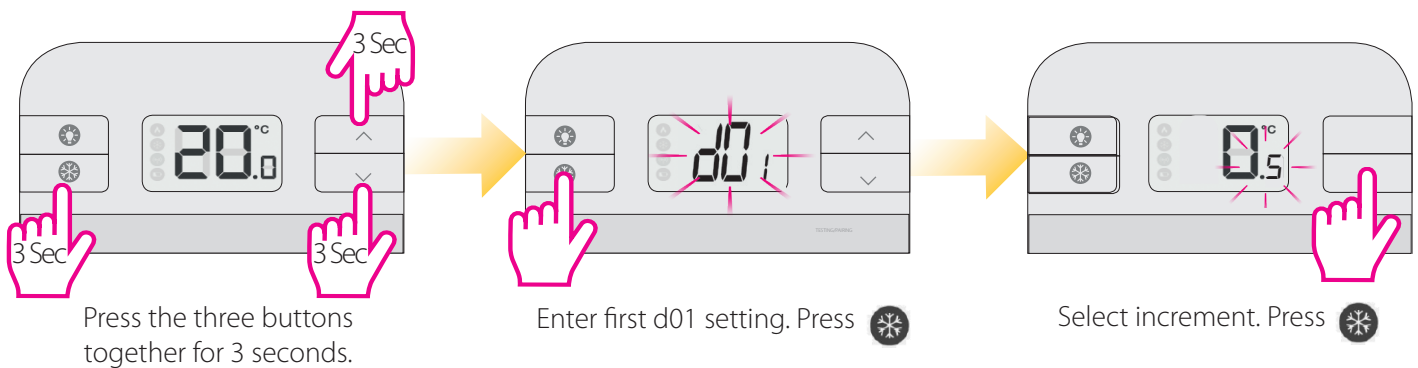

Continue adjusting the d02 and d03 following the same steps as above. Once you have finished setting up all the parameters, press  to exit to home screen, or don't press any button for 10 seconds and it will exit automatically.

| dxx | Function | Parameter | Description | Default value |
|-----|--------------------------------|----------------|---|---------------|
| d01 | Temperature display increments | 0.1°C or 0.5°C | Select the temperature display increments | 0.5°C |
| d02 | Temperature offset | +/-3.0°C | Calibrate your thermostat temperature | 0.0°C |
| d03 | Frost setpoint | 5.0°C-17.0°C | Set the Frost Point temperature | 5.0°C |

Initial Power UP

After power up, the thermostat is reset. During system reset, all LCD icons are displayed for 2 seconds and the keys are locked. After that, all keys are unlocked and the thermostat is initialized. Then software version is shown. The typical reset display is shown below.

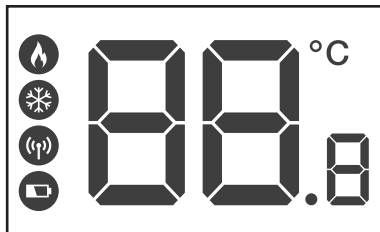

The following table shows the settings of the RT310RF digital thermostat after Power on, or after TEST/PAIRING button is pressed:

| Function | Status after Reset |
|-------------------------------|--|
| Operation Mode | Normal mode |
| Room Temperature | 22.0°C, to be renewed within 5 seconds |
| Setpoint Temperature | 20.0°C |
| °C indicator | On |
| Frost Protection indicator | Off |
| Heat indicator | Off |
| Low-Battery Warning indicator | Off, to be renewed within 5 seconds |
| Output Relay | Off |

Reviewing Setpoint Temperature

Press  or  to review Setpoint temperature. The flame icon won't be turned on.

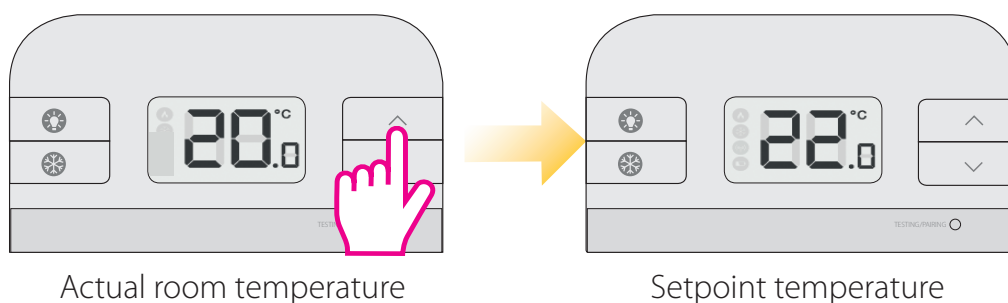

When operating in Frost protection mode, the LCD will show frost setpoint with the Frost Protection indicator displayed.

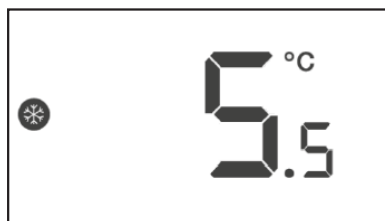

Press Backlight or wait 2 seconds without key press to return to normal operation, room temperature will be displayed.

Adjusting setpoint

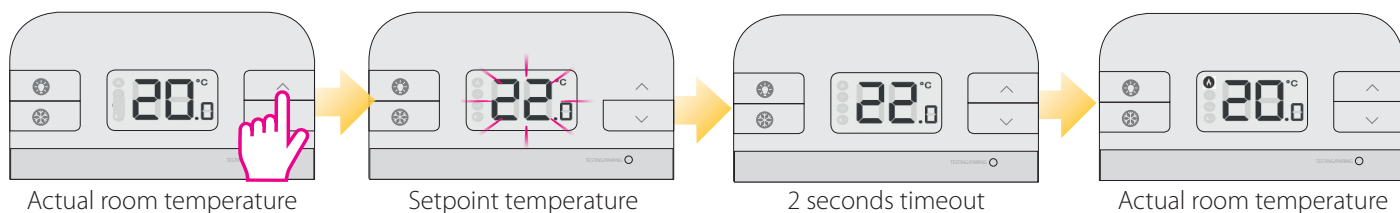

By changing the Setpoint temperature, you are permanently altering your temperature. You can change the set point temperature very easily while you are reviewing the set point temperature. Press the UP or DOWN keys repeatedly to change the temperature setting. The set point temperature will flash to indicate that it can be changed: the temperature will be changed in 0.5°C steps per key press.

The RT310RF will return to Normal mode if no keys are pressed for more than 2 seconds. Once the new control has been implemented, the change is permanent override until new Setpoint is set again. Setpoint temperature cannot be changed if Frost Protection mode is enabled.



Frost Protection

Press FROST button  to activate Frost Protection.

The Setpoint temperature is automatically set to frost setpoint to prevent freezing. If the room temperature is lower than the frost setpoint, frost protection will be enabled. When Frost Protection is enabled, the user should not be able to press  or  to adjust frost Setpoint temperature, this feature being accessible only in installation mode. Please refer to page 7 on more information on Installer Mode. Press FROST button  again to de-activate Frost Protection.

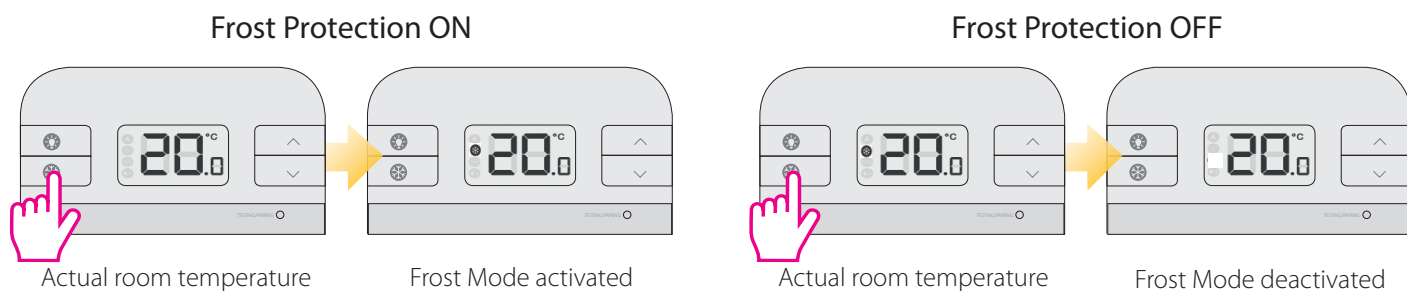

Note: The setpoint frost temperature can be reviewed by pressing the Up button once, but can only be changed in Installer Mode. For more information about entering installer mode, please refer to page 7.

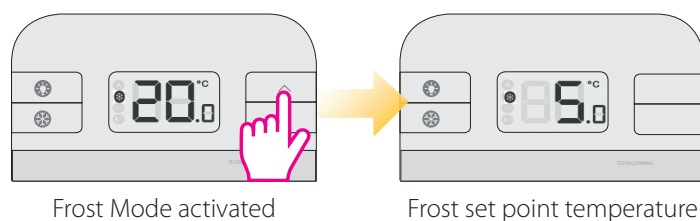

LCD backlight



- LCD backlight is activated when  or any key is pressed. The backlight will be turned off in 15 seconds after all keys are released.
- LCD backlight will not operate when battery is low.

Low battery detection

Battery voltage is checked every minute. When the battery voltage drops to a certain level, the Low-Battery warning  indicator appears.

- The thermostat functions normally during low battery. However, user must change the batteries as soon as possible before the battery is too weak for the normal operation to be assured.
- When you change the batteries, you have about 30 seconds to do so without losing your settings.

Sleep Mode

Press and hold  and  for 3 seconds simultaneously to enter the Sleep mode. All the functions will be paused to save battery power. While in sleep mode:

- The LCD display will be blank.
- All output from the Control Unit will be turned off immediately.

Press any key to wake up the RT310RF and cancel SLEEP mode.

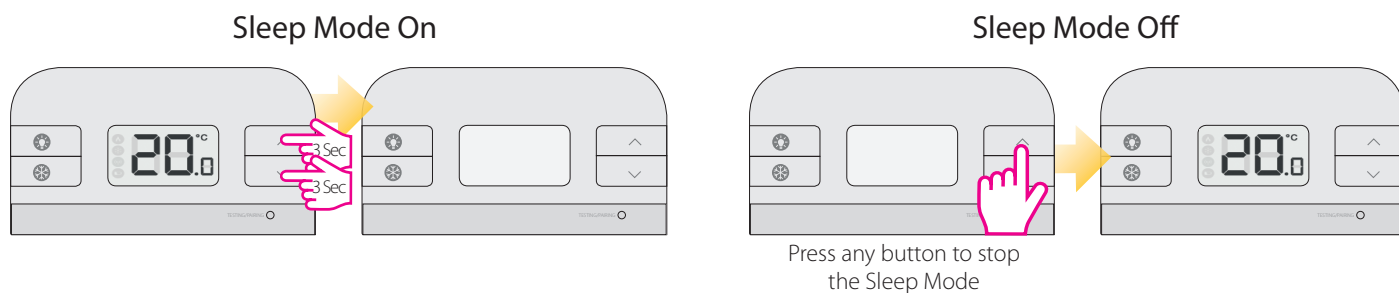

Temperatures outside operating range

Temperatures below 10 °C are displayed without the leading '0'. Temperatures exceeding the measurable range will be indicated by 'HI' for temperatures above the upper limit, and 'LO' for temperatures below the lower limit, as shown in the images.



Factory reset

Remove the batteries without pressing any button. Wait 2 minutes and insert the batteries again.



Technical info

| Product Specification | |
|-------------------------------------|---|
| Model: | RT310RF |
| Type: | Wireless Heating Thermostat |
| Frequency: | 868MHz |
| Temperature | |
| Scale: | °C |
| Range: | 5.0°C - 35.0°C |
| Resolution: | 0.1/0.5°C and 0.5°C default |
| Temperature Measurement Accuracy: | Maximum +/-0.25°C at 20°C |
| Display Range: | 5.0°C - 35.0°C |
| Display Resolution: | 0.1/0.5°C and 0.5°C default |
| Frost Protection | |
| Setting: | 5 °C |
| Setpoint Temperature Range: | 5 °C to 17 °C |
| Thermostat | |
| Power Source: | 2 AA-sized Alkaline Batteries for a minimum of 12 months operation. |
| Receiver | |
| Power Source: | 230Vac 50Hz |
| Switch Rating | |
| Switching Voltage: | 230V/50Hz |
| Switching Current: | 16A resistance 8A inductance |
| Protection Rating: | IP 30 |
| Environment | |
| Operating Temperature/ Humidity: | 0°C ~ 50°C, 10% – 90% non-condensing |
| Storage Temperature/ Humidity: | -20°C~- 60°C, 10% – 90% non-condensing |

Warranty

SALUS Controls warrants that this product will be free from any defect in materials or workmanship, and shall perform in accordance with its specification, for a period of two years from the date of installation. SALUS Controls sole liability for breach of this warranty will be (at its option) to repair or replace the defective product.

Customer Name:

Customer Address:

..... Post Code:

Tel No: Email:

Company Name:

Tel No: Email:

Installation Date:

Installer Name:

Installer Signature:

SALUS Controls PLC

SALUS House

Dodworth Business Park South,
Whinby Road, Dodworth,
Barnsley S75 3SP, UK.

Sales: T: +44 (0) 1226 323961
E: sales@salus-tech.com

Technical: T: +44 (0) 1226 323961
E: tech@salus-tech.com

www.salus-controls.com



SALUS Controls is a member of the Computime Group

Maintaining a policy of continuous product development, SALUS Controls plc reserves the right to change specification, design and materials of products listed in this brochure without prior notice.

For the latest PFD Instruction Manual, go to www.salus-manuals.com

Issue Date: April 2017, V001

