

Art. No. 0020017744

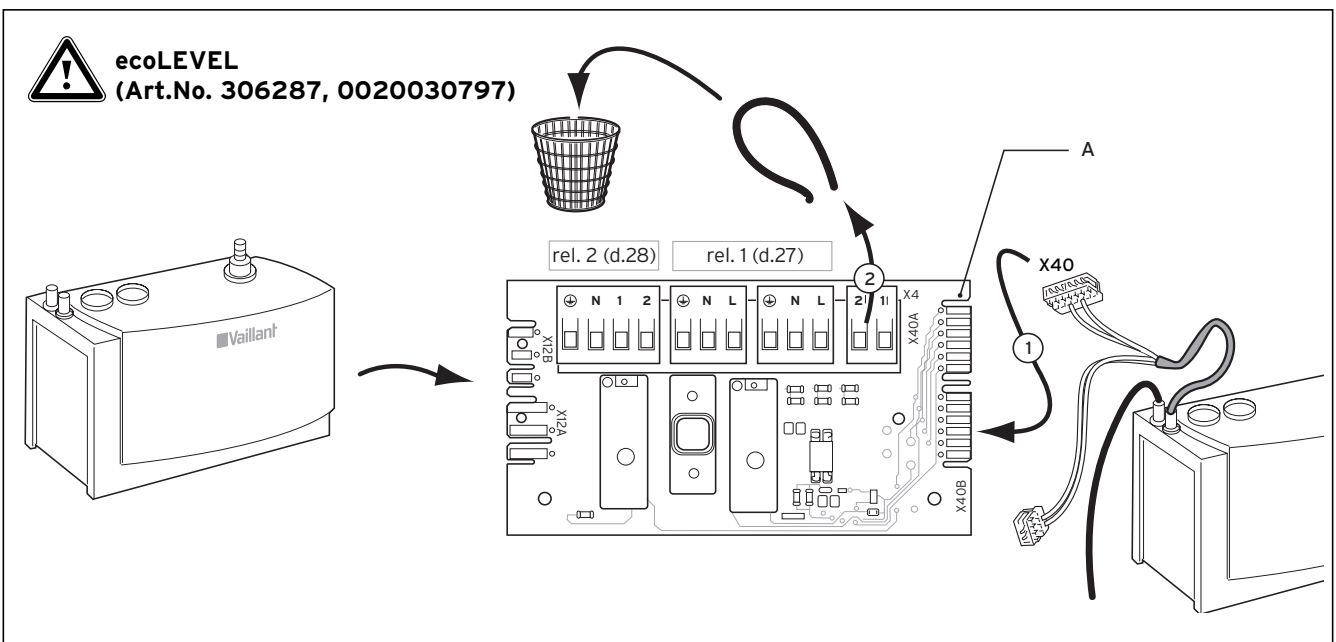

Multifunktionsmodul 2 aus 7
Multifunctional module 2 in 7

VR 40

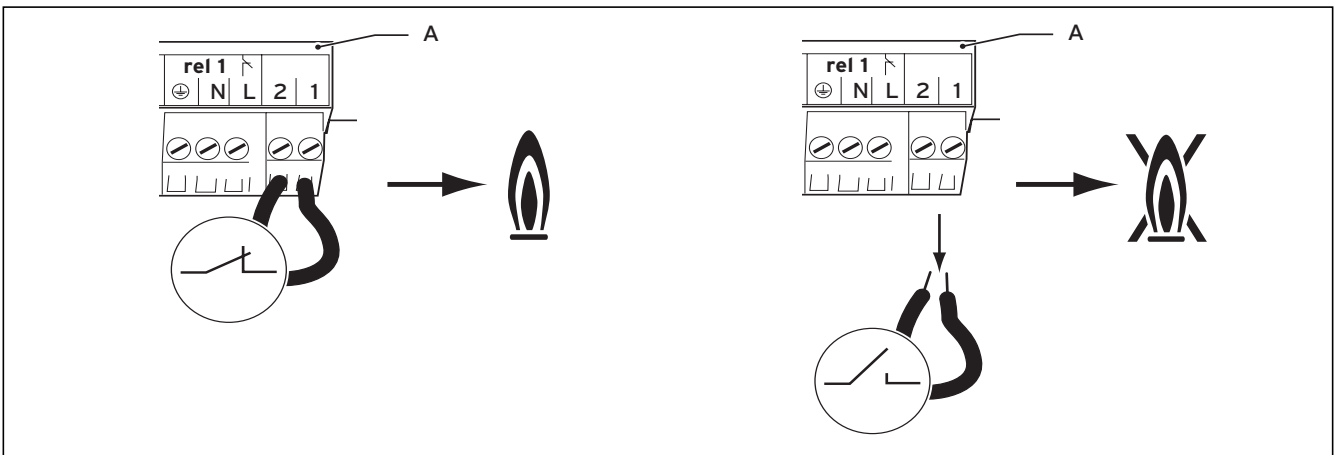
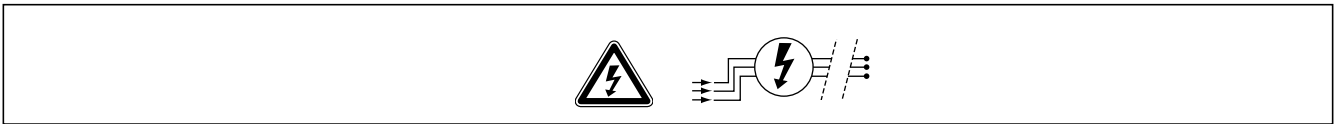
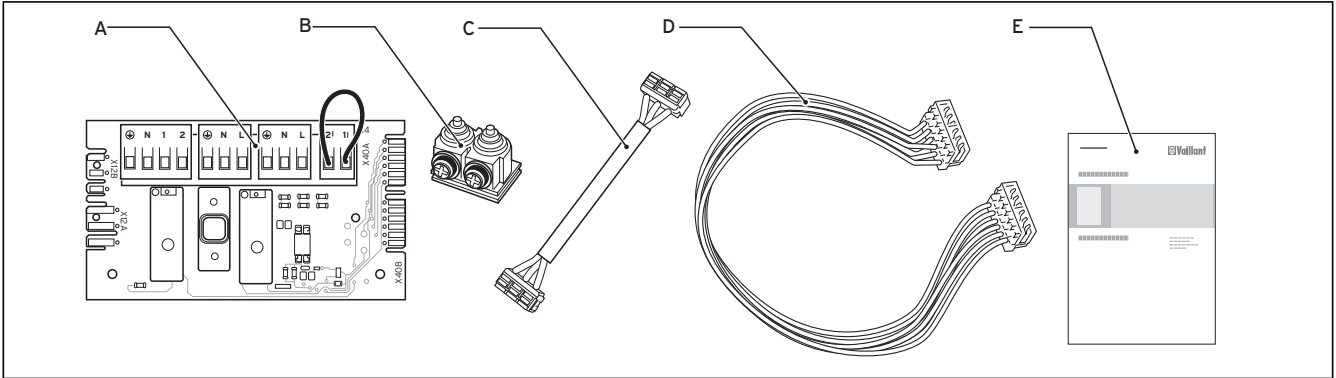

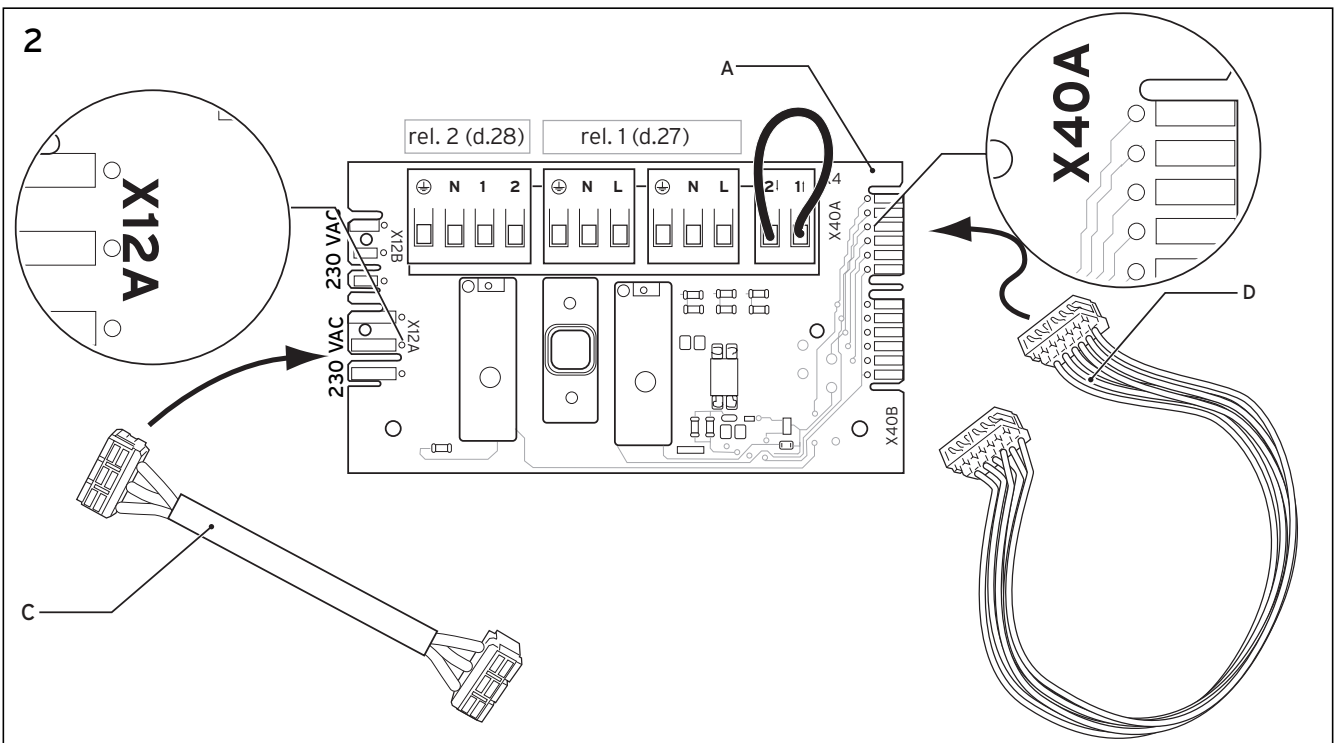
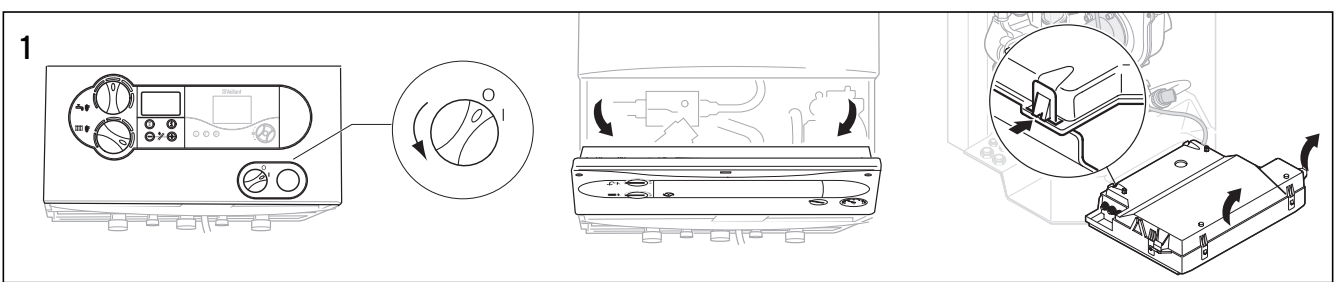
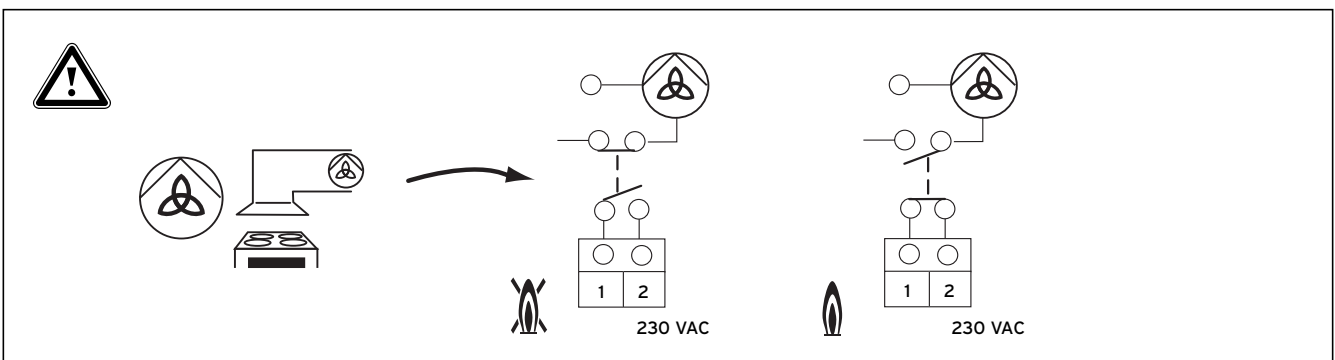
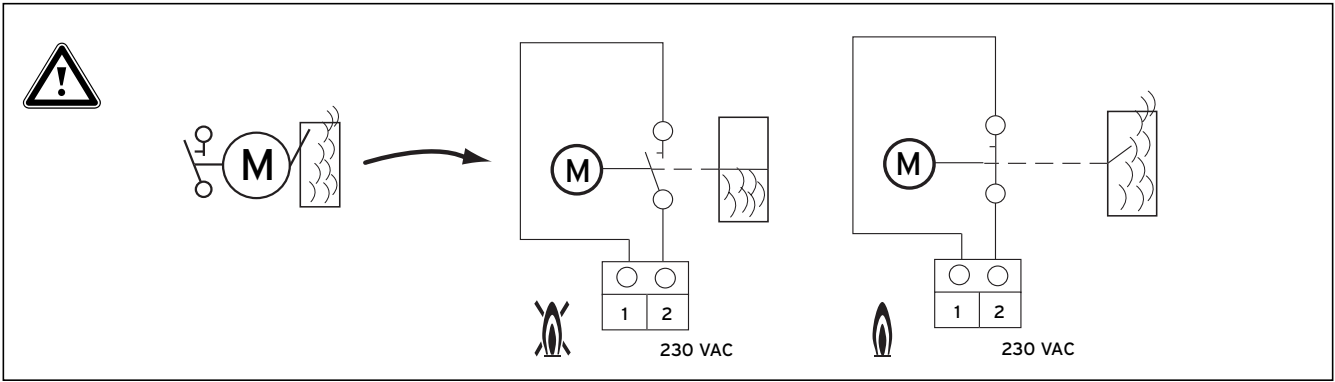

3

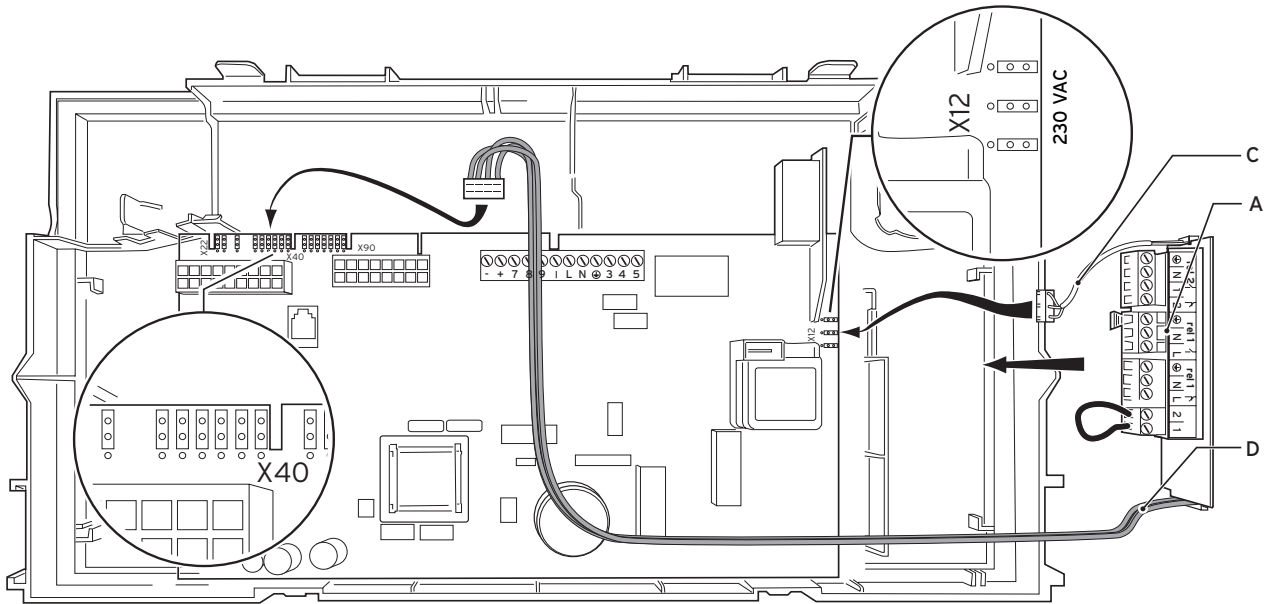



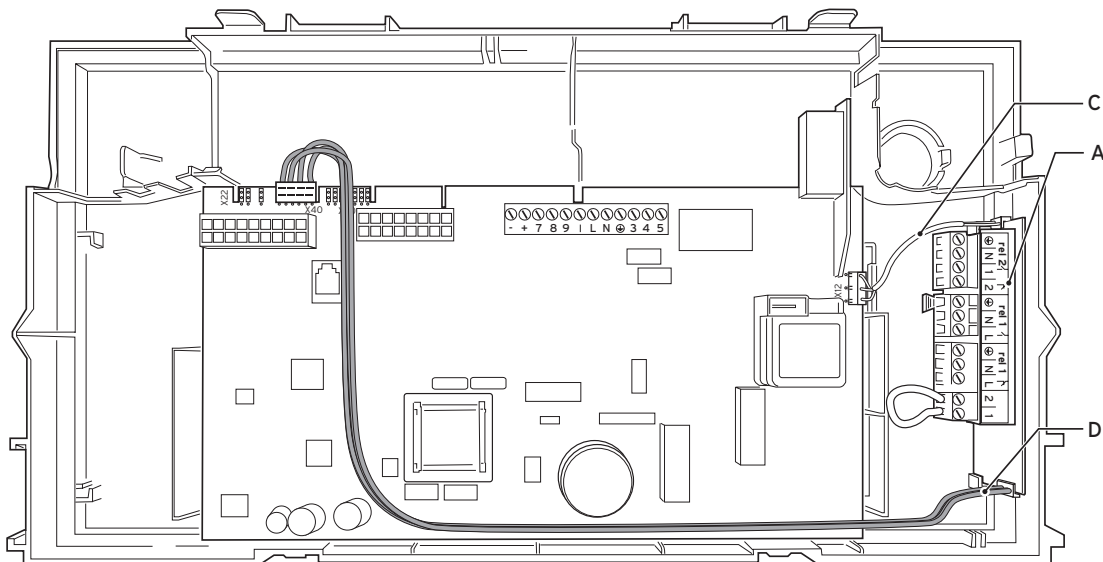

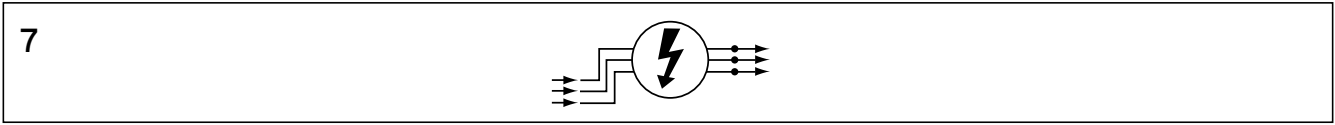
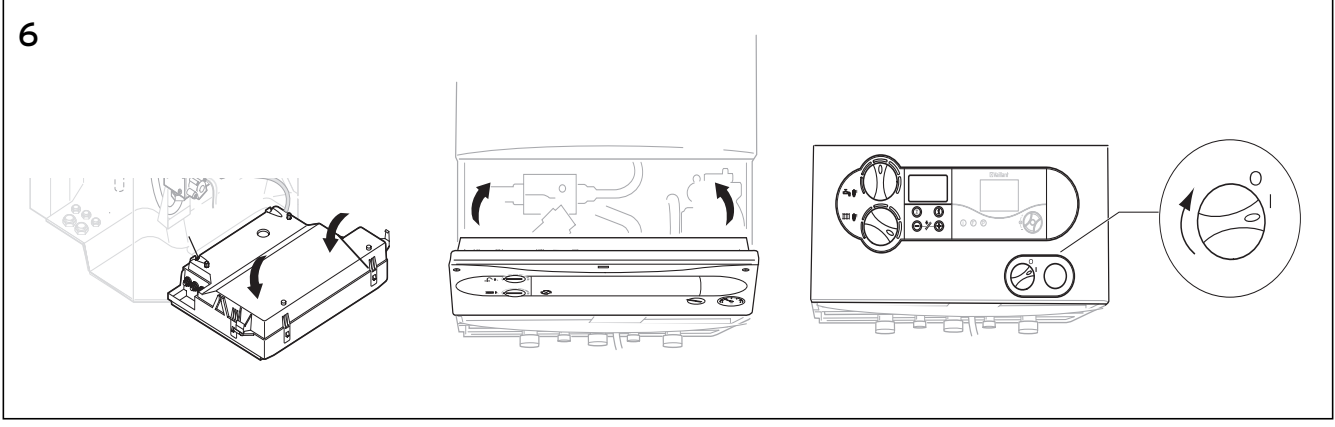
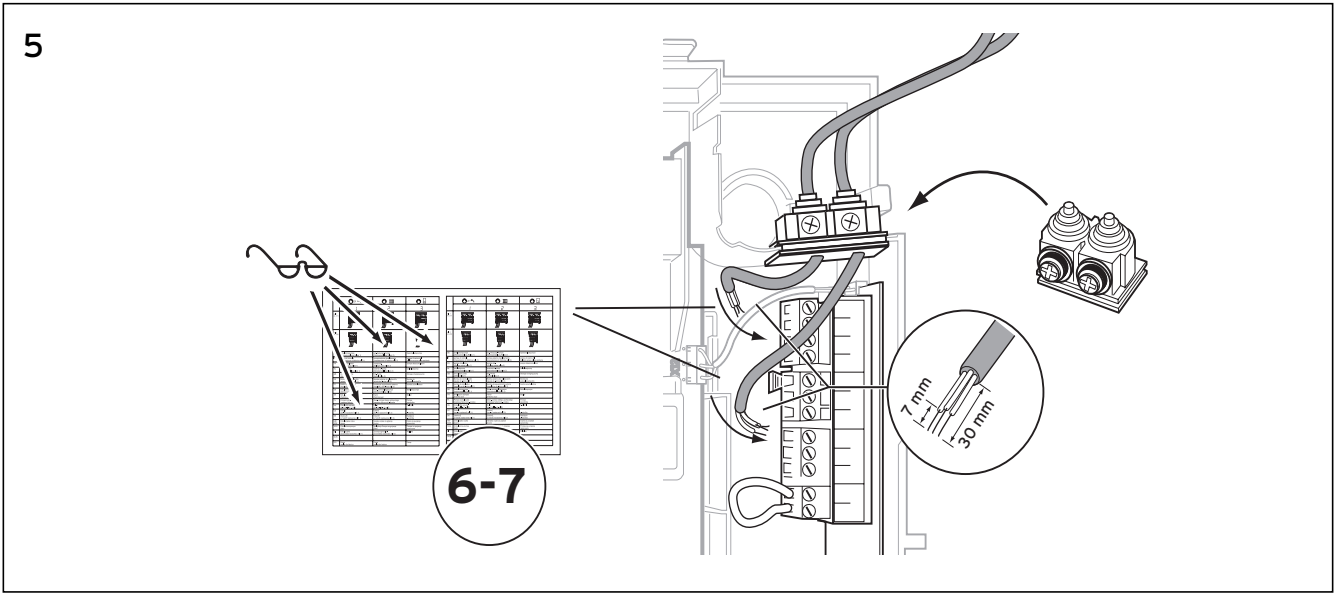
4



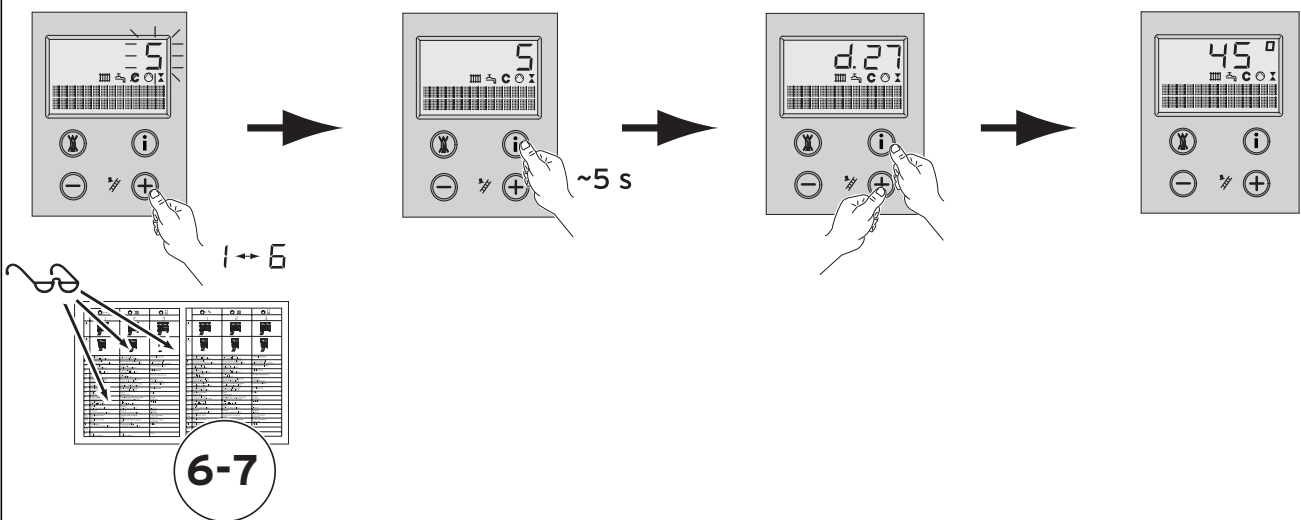
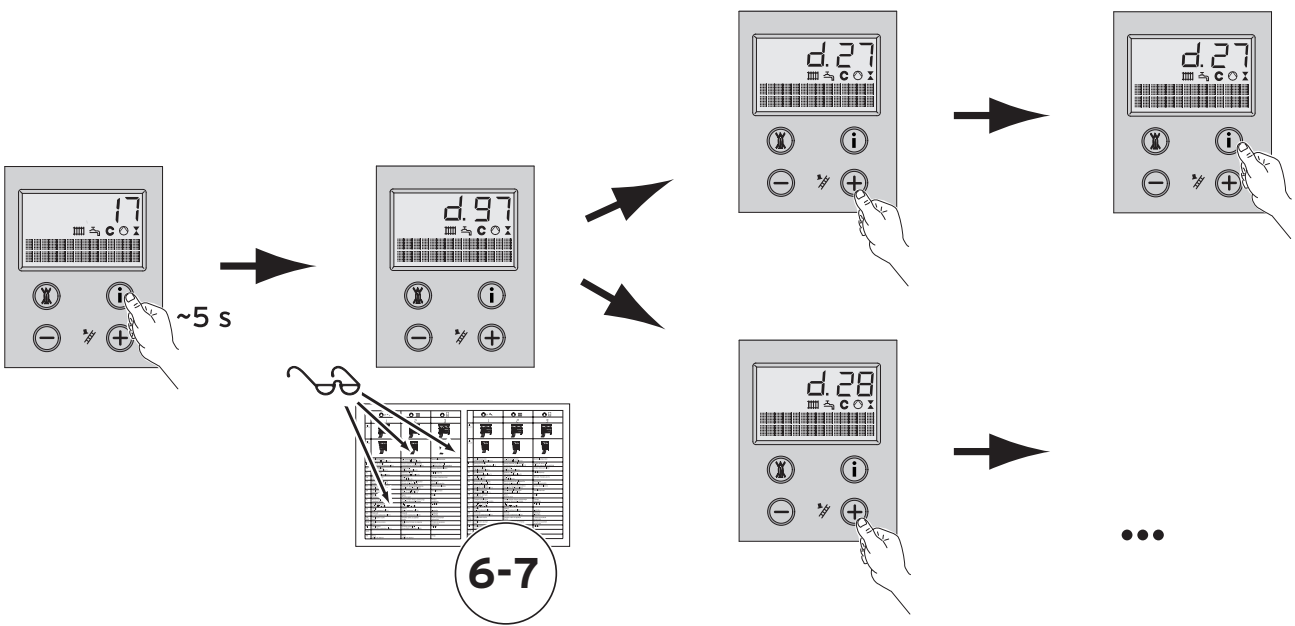
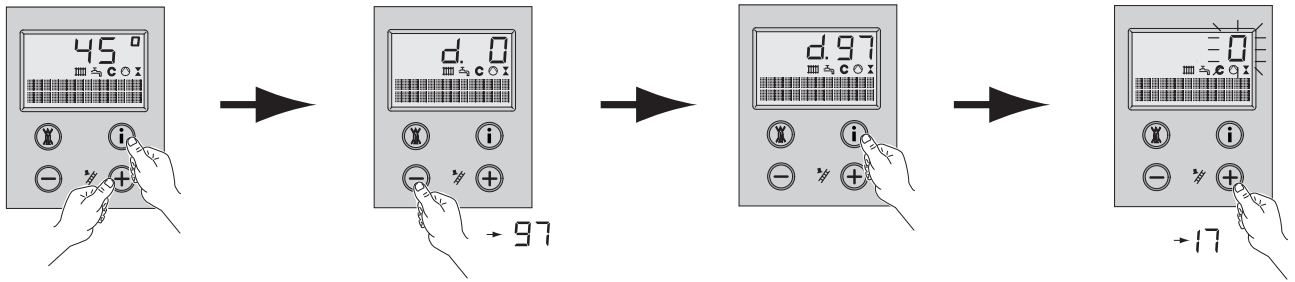



8

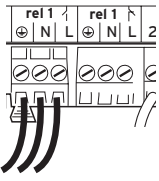
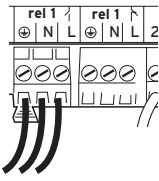
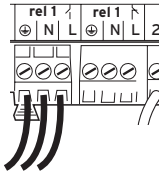
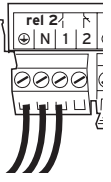
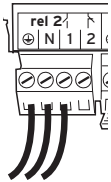
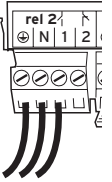

	 ZP 		
	1	2	3
rel.1 (d.27)			
rel.2 (d.28)			
DE	Zirkulationspumpe (Werkseinstellung Relais 1)	ext. Heizungs-Pumpe (Werkseinstellung Relais 2)	Speicherladepumpe
IT	pompa di ricircolo (impostazione di fabbrica relè 1)	pompa esterna riscaldamento (impostazione di fabbrica relè 2)	pompa di carico del bollitore acqua calda sanitaria
FR	pompe circulation (réglage usine relais 1)	pompe ext. (réglage usine relais 2)	pompe d'accumulation
NL	circulatiepomp (fabrieksinstelling relais 1)	externe cv-pomp (fabrieksinstelling relais 2)	boilerlaadpomp
GB	Circulation pump (default relay 1)	Ext. Pump (default relay 2)	Storage charging pump
ES	Bomba de recirculación (ajuste de fábrica relé 1)	Bomba externa de calefacción (ajuste de fábrica relé 2)	Bomba de sobrealimentación
PT	bomba de circulação (regulação de fábrica relé 1)	bomba de aquecimento externa (regulação de fábrica relé 2)	bomba acumuladora
DK	Cirkulationspumpe (fabriksindstilling relæ 1)	Ekst. varmeanlægspumpe (fabriksindstilling relæ 2)	Beholderpumpe
TR	Sirkülasyon pompası (Fabrika ayarı Röle 1)	Harici ısıtma pompası (Fabrika ayarı Röle 2)	Boylor ısıtma pompası
PL	Pompa cyrkulacyjna (nastawa fabryczna - przekaźnik 1)	Zewn. pompa obiegu grzewczego (nastawa fabryczna - przekaźnik 2)	Pompa ładowania zasobnika
HU	Cirkulációs szivattyú (gyári beállítás 1. relé)	Kül.. fűtővíz-szivattyú (gyári beállítás 2. relé)	Tárolótöltő szivattyú
CZ	Cirkulační čerpadlo (tovární nastavení relé 1)	Externí čerpadlo topného okruhu (tovární nastavení relé 2)	Čerpadlo k ohřevu zásobníku
SK	Obehové čerpadlo (výrobné nastavenie relé 1)	Externé čerpadlo vykurovacieho okruhu (výrobné nastavenie relé 2)	Nabíjacie čerpadlo zásobníka
HR/ SOE	Cirkulacijska crpka (tvornička namještenost relej 1)	Vanjska crpka za grijanje (tvornička namještenost relej 2)	Crpka za punjenje spremnika
SRB	Cirkulaciona pumpa (fabrički podešen relej 1)	Spoljašnja Pumpa za grejanje (fabrički podešen relej 2)	Pumpa za punjenje rezervoara
SI	Cirkulacijska črpalka (tovarniška nastavitve, rele 1)	Zunanja ogrevalna-črpalka (tovarniška nastavitve, rele 2)	Polnilna črpalka zbiralnika
GUS	Циркуляционный насос (заводская настройка реле 1)	Внешний отопительный насос (заводская настройка реле 2)	Насос нагрева водонагревателя
RO	Pompă de recirculare (reglaj din fabricație releul 1)	Pompă externă de încălzire (reglaj din fabricație releul 2)	Pompă de încărcarea a boilerului

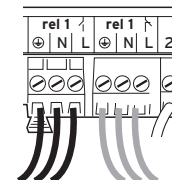
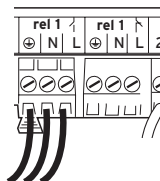
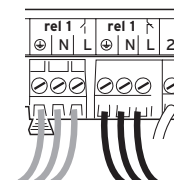
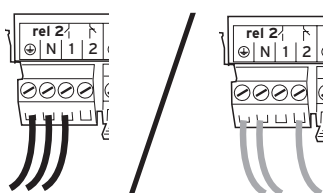
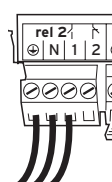
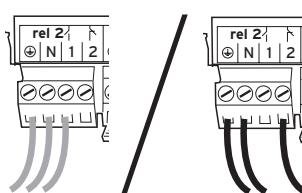
				
	4		5	6
rel.1 (d.27)				
rel.2 (d.28)				
DE	Abgasklappe/ Dunstabzughaube	Rückmelde-Signal	externes Gasventil	externe Fehlermeldung/ Betriebsanzeige
IT	sportello fumi/ aspiratore domestico	segnale di conferma	valvola intercettazione gas esterna	Indicatore disfunzioni/ Indicatore d'esercizio
FR	clapet évacuation/ hotte aspirante	signal de réaction	vanne gaz externe	message d'erreur externe/ Affichage de l'état de fonctionnement
NL	verbrandingsgasklep/ wasemkap (afzuigkap)	bevestigingssignaal	extern gasventiel	externe storingsmelding/ inbedrijfmelding
GB	Flue gas flap/ extractor hood	checkback signal	External gas valve	External error message/ Operation indicator
ES	Panel de evacuación de gases/ campana de extracción de con- densación	Señal de respuesta	Válvula de gas externa	Aviso de error externo/ indicador de funcionamiento
PT	tampa dos gases de exaustão/ extractor de fumos	Sinal de confirmação	válvula do gás externa	mensagem de erro externa/ indicador de funcionamento
DK	Røggasklap/ emhætte	Tilbagemeldings- signal	Ekstern gasventil	Ekstern fejlmelding/ driftskontrollampe
TR	Baca gazı kapağı/ Aspiratör	Geri bildirim sinyali	Harici gaz vanası	Harici arıza mesajı/ işletme göstergesi
PL	Przepustnica spalin/ wyciąg oparów	Sygnal zwrotny	Zewnętrzny zawór gazu	Zewnętrzny komunikat awaryjny/ dioda kontrolna
HU	Füstgázcsappantyú/ páraelszívó-burkolat	visszajelzési jel	Külső gázszelep	Külső hibaüzenet/ üzemkijelző
CZ	Spalinová klapka/ kryt odvodu par	signál zpětné vazby	Externí plynový ventil	Externí chybové hlášení/ indikátor provozu
SK	Spalinová klapka/ kryt odsávača pár	Signál spätného hlásenia	Externý plynový ventil	Externé chybové hlásenie/ indikátor prevádzky
HR	Zaklopka za ispušni plin/ poklopac za odvod plinova	signal s povratnom informacijom	Vanjski plinski ventil	Vanjska dojava greške/ pokazivač načina rada
SRB	Klapna dimnih gasova/ poklopac za odvod gasova	signal sa povratnom informacijom	Spoljašnji gasni ventil	Spoljašnja prijava greške/ pokazivač načina rada
SI	Loputa izpušnih plinov/ auba za odvajanje pare	povratni signal	Zunanji plinski ventil	Zunanje javljanje napake/ indikator obratovanja
GUS	Заслонка газохода/ Вытяжной коппак	Сигнал обратной связи	Внешний газовый клапан	Внешний индикатор сообщения об ошибке/рабочий индикатор
RO	Clapetă pentru gaze arse/ hotă	Semnal de reavizare	Ventil extern de gaz	Mesaj extern de eroare/ indicator funcțional