

Consumer information

Thermostatic valves Thermolux K

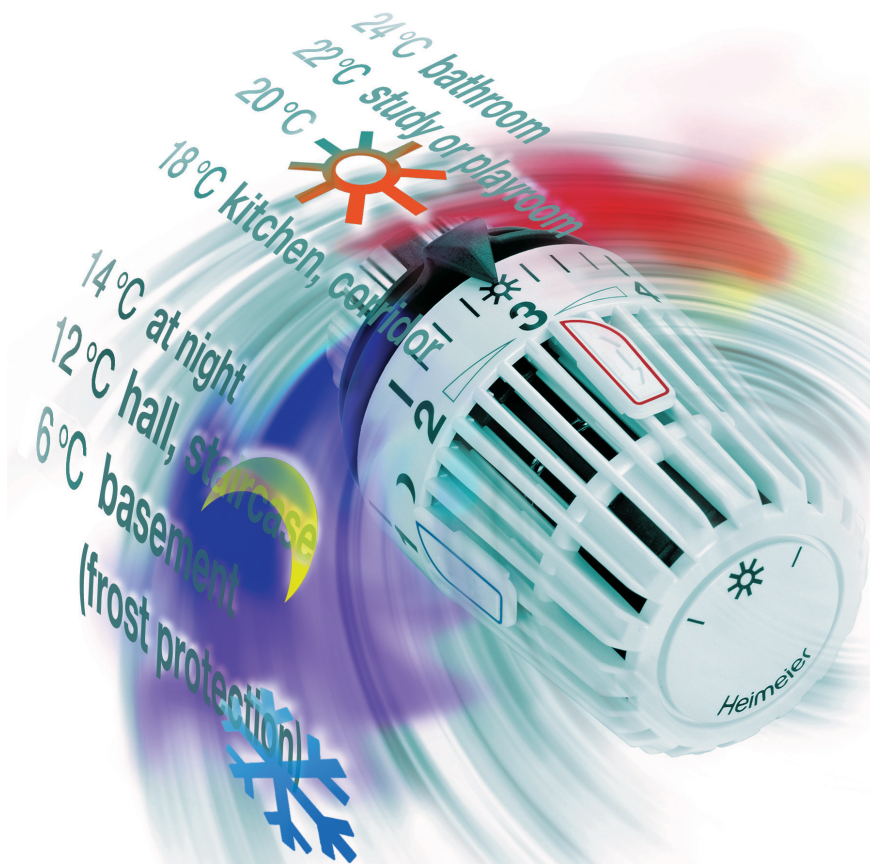

Please keep this brochure in a safe place.



Boiler-Gas.ru

Перейти на сайт

To be precise.





Short instructions	1
Function	2
Important notes	3
<ul style="list-style-type: none">- Special features- Cleaning- Maintenance & service- Easier operation for visually handicapped persons	
Mounting instructions	4
<ul style="list-style-type: none">- Build-in sensor- Remote sensor	
Recommended Room Temperature	6
Temperature setting	7
<ul style="list-style-type: none">- Reduced night performance- Anti-frost protection setting- Front side setting aid- Setting aid for visually handicapped persons	
Economy clips	8
<ul style="list-style-type: none">- Marking of a temperature setting<ul style="list-style-type: none">- Uper marking of a temperature range- Lower marking of a temperature range- Limiting of a temperature setting<ul style="list-style-type: none">- Upper limitation of a temperature range- Lower limitation of a temperature range- Cancelling the limiting- Blocking of a temperature setting<ul style="list-style-type: none">- Cancelling of the blocking	
Disturbance – Causes – Remedies	10
Thermolux K with remote sensor	12
Accessories	13
Useful comments / Technical data	14
<ul style="list-style-type: none">- Appropriate venting- Cost saving by using external heat	
List of headwords	15

Short Instructions

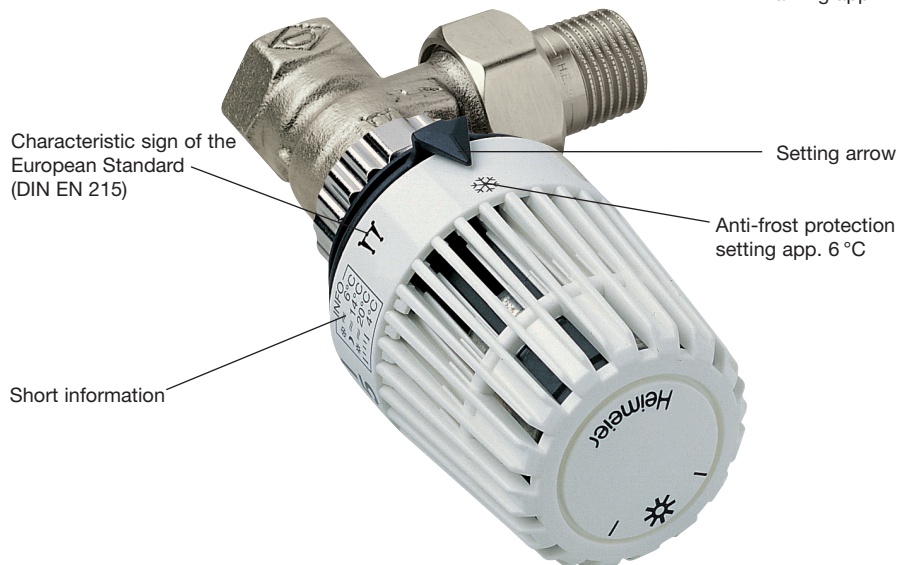
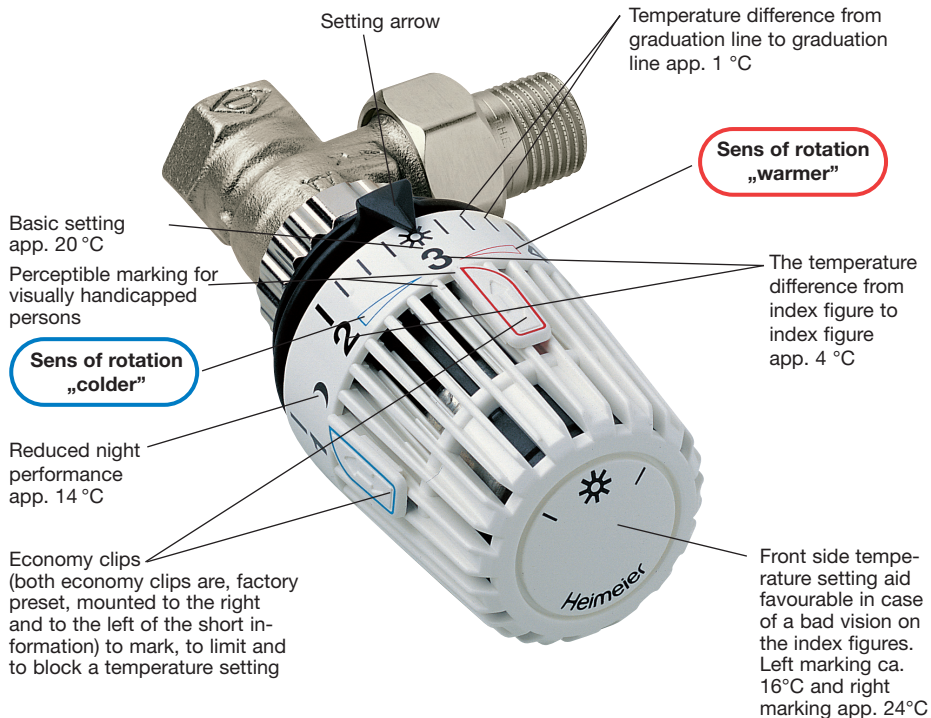

Operation and outfit of the depicted Thermolux K thermostatic valve with incorporated sensor are identical with those for valves equipped with a remote sensor (please see page 12).

Function

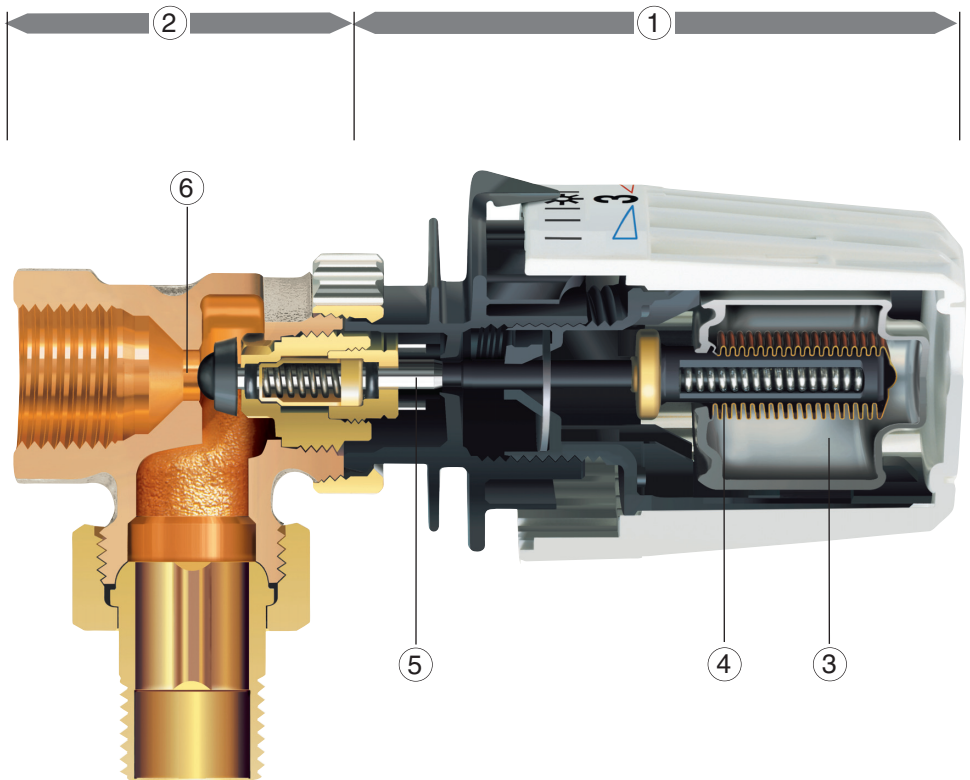

Heimeier Thermolux K thermostatic valves are autonomously operating temperature controllers which do not require any electric power supply or connection or any other kind of external energy. They serve to control the individual room temperature and, thus, save energy. The Heimeier thermostatic valves allow different temperature settings which can be marked or temperature ranges be limited or settings be blocked respectively.

Heimeier Thermolux K-thermostatic valves consist of the thermostatic head ① and the thermostatic valve

body ②. If temperature rises e.g. due to insolation, electric appliances or people in the room, the liquid in the temperature sensor ③ will expand.

The corrugated tube ④ will be compressed and so throttles the water supply to the radiator by means of the valve spindle ⑤ in the valve seat ⑥. Should the room temperature drop the described procedure will be reversed. Therefore, the thermostatic head only needs actuation in order to change the individual setting of the room temperature.

Important Notes

Dear Customer!

You dispose now of the Thermolux K thermostatic valve which is a product of highest quality made by Germany's leading manufacturer of heating valves.

The Heimeier Thermolux K thermostatic valves are GEN certified and were tested according to DIN EN 215. They offer you, on the pre-condition of a correct usage, a maximum of comfort and energy saving.

This user information intends to make you acquainted with the operation and useful application of the thermostatic valves. Even if you know already well the operation and handling, you still should read these instructions carefully and please keep this booklet in a safe place and pass it on to any possible later user.

For easier reference and orientation please consult the coloured subdivisions of the table of contents.

Should you look for some specific item, please refer to page 15 containing a list of headwords.



The mounting of the thermostatic valve should exclusively be carried out by a qualified installer (please see Mounting Instructions on page 4).

Your installer will help you if you wish to block an individual temperature setting or to limit the temperature setting range internally, i.e. unchangeable from outside, either to a higher or to a lower temperature level of your thermostatic valves.

Interesting accessories are offered on page 13.

Special features

This thermostatic head offers several distinctive features for energy savings and uncomplicated operation:

- The most important temperature settings are shown in an abridged form as INFO on the thermostatic head
- Economy clips, blue and red
- Reduced night performance 
- Temperature setting aid on the front side
- Anti-frost protection setting 

Cleaning

The thermostatic head should only be cleaned with the upholstery brush of a vacuum cleaner or in case of heavier soiling, use lukewarm water containing a mild domestic cleaning agent.

Maintenance and Service

In principle Heimeier's thermostatic valves do not require any maintenance at all.

In case of questions or possible disturbances (see pages 10 and 11) please apply to your installer (see reverse page of this brochure) or contact Heimeier directly.

Easier operation for visually handicapped persons

With a view to achieving an easier temperature setting, the thermostatic head disposes of perceptible markings for the basic setting (please see page 7).

Mounting instructions

Incorporated sensor, remote sensor

The thermostatic valve with incorporated sensor must not be mounted in such a way that the valve will be covered with any curtains, radiator covers or panelling etc., or be fitted in

narrow alcoves or even be mounted in vertical position as in such cases no precise temperature control will be possible. Otherwise a remote sensor or remote dial will be indispensable.

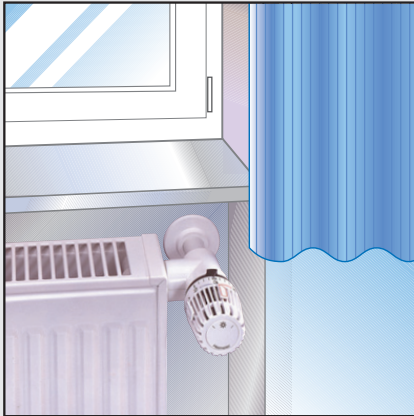

correct

The air of the room can circulate around the thermostatic head without any obstacle.



incorrect

The thermostatic head with incorporated sensor must not be fitted in a vertical position.



correct

The remote sensor can capture the room temperature without any obstacle.

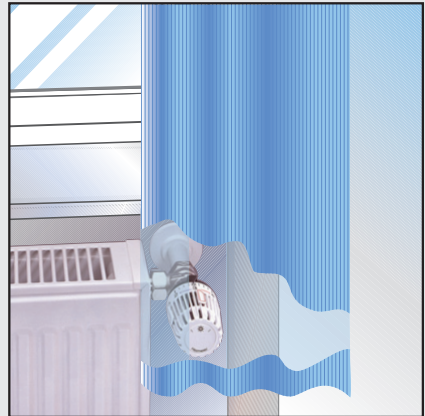

incorrect

The thermostatic head with incorporated sensor must not be covered with curtains.

Remote dial

When mounting an underfloor convector (radiator mounted underfloor), or if the thermostatic head is covered with furniture or any similar item, a

remote dial should be installed. The latter captures the room temperature without any obstacle and offers a comfortable operation for the purpose of setting the temperature.

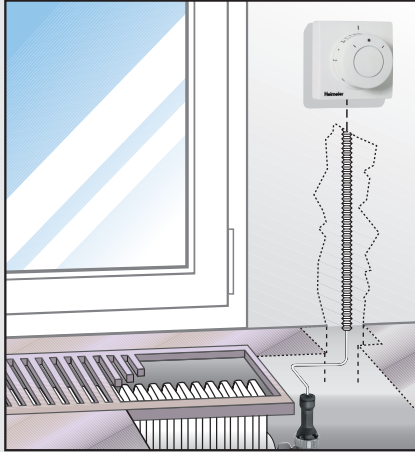

underfloor convector

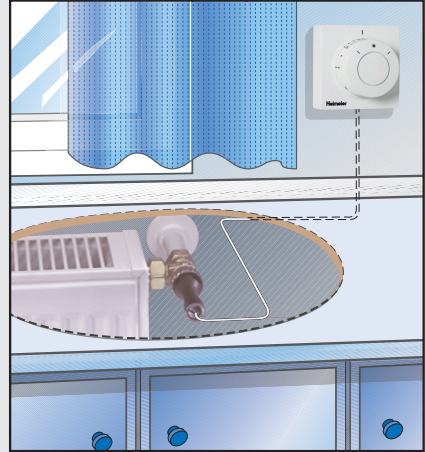

built-in cupboard

Note

All Heimeier thermostatic heads are duly adjusted in a climatic chamber without any external influences like heat accumulation, insulation etc. Depending upon the mounting or operating conditions, the desired temperature can, in isolated cases, only be achieved after having set a deviating temperature. But this, of course, has neither any influence on

the regulating accuracy nor on energy saving. As a rule heating systems are usually so designed that excessive temperatures (Index figures 4 and 5) will not be reached in most cases. This, the more so, is applicable to weather-controlled supply temperatures or to the heat generator respectively.

Recommended Room Temperatures

The following room temperature settings are recommended for the relevant rooms in due consideration of energy and cost saving.

Setting position	Room temperature ca.	to be recommended for e.g.
------------------	----------------------	----------------------------

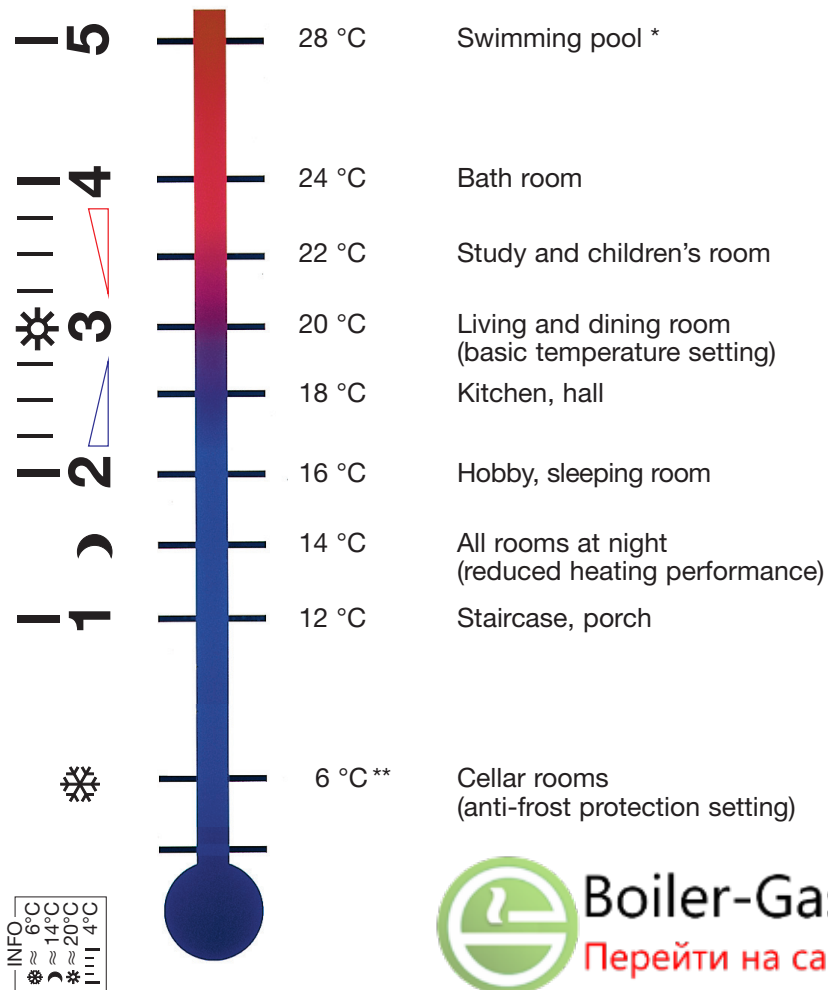

* Should higher temperatures be required in a swimming pool then special thermostatic heads are available (set value ranges between 15°C to 35°C).

** Also available are thermostic heads in a version with an additional zero temperature setting position and, thus, the lowest temperature is 0°C.

Temperature Setting

Every desired room temperature can be set by simply turning the thermostatic head (◀ = colder, ▶ = warmer). In this case, the setting arrow must point at the relevant setting position (index figure, graduation line, symbol). Intermediate adjustments are possible. The temperature difference from index figure to index figure is about 4°C, and from graduation line to graduation line about 1°C. Recommended by us is a temperature setting of the index figure 3 with the sun symbol, and this represents the basic setting of about 20°C. With a view to saving energy a temperature setting above index figure 4 should be avoided, provided that already a lower temperature setting will be sufficient for comfortableness. It should especially be noted that only 1°C of a lower temperature saves approx. 6% of the heating cost.

Reduced night performance ☾

In the evening, the thermostatic head should be turned to the right to reach the moon symbol, or, when using the blue economy clip as a limitation, to this limit stop. Experience proved that the ☾-setting will be fully sufficient. In the morning the thermostatic head must simply be turned to the left in order to reach the desired temperature setting position or, when the red economy clip will be used as a limitation, to this limit stop. Even during a longer absence a temperature reduction is advised to be effected.

Anti-frost protection setting ❄

In case of a longer absence in winter, the anti-frost position warrants that

the temperature in the rooms will not drop below 6°C, provided, however, the heating system is in operation and, thus, the rooms will be protected from frost damage. This said anti-frost protection setting can also be chosen for rooms unused during the winter period.

Front side setting aid

The front side of the thermostatic head serves as temperature setting aid in case of bad vision on the circumferential printing or as setting orientation from a larger distance. The settings of the markings left and right to the ❄ correspond to 16°C or 24°C respectively.

Setting aid for visually handicapped persons

If the thermostatic head is turned in such a way that the perceptible markings are opposite to the setting arrow, a temperature setting of ca. 20°C will be reached. Starting from this said basic setting by feeling and counting the grooves and by correspondingly turning the thermostatic head to the desired setting position, the desired temperature setting position can be reached whenever the relevant groove will be opposite to the setting arrow. The distance between each groove in the thermostatic head is about 1°C.

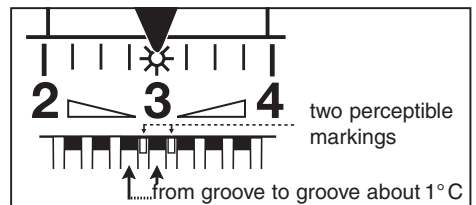

Economy clips

The thermostatic head will be supplied, factory preset, with two economy clips. These economy clips are at first mounted to the right and to the left of the short information.

These clips allow a variable

- marking,
- limiting or
- blocking

of an optimal temperature setting.

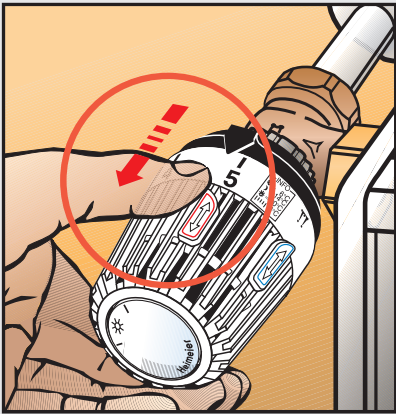

Fig. 1: pull back the economy clip

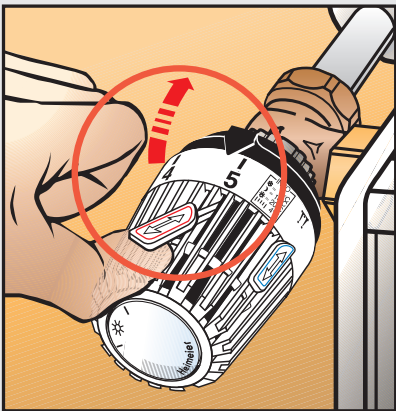

Fig. 2: lift and remove the economy clip

Marking of a temperature setting (without limitation)

Upper marking of the temperature range

For this purpose pull back the **red economy clip** with your thumb up to the stop (please see fig.1), then lift and remove the economy clip (please see fig. 2). Thus, the thermostatic head can be turned and set to the desired temperature, e.g. index figure 3 = 20°C. Thereafter, the **red economy clip** must be inserted in the groove to the **right** of the index figure 3 (please see fig. 3), then push the clip forward and afterwards pull it back to the stop with your thumb.

Lower marking of the temperature range

For this purpose the **blue economy clip** must be pulled back up to the stop with your thumb, then lift and remove the clip. The thermostatic head can now be turned to the desired temperature, e.g. moon symbol = 14°C. Thereafter, the **blue economy clip** is to be inserted in the groove to the **left** of the moon symbol (please see fig. 4), push the clip forward and pull it back with your thumb up to the stop.

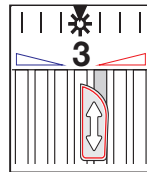

Fig. 3: red economy clip for upper marking/limitation, e.g. 20°C

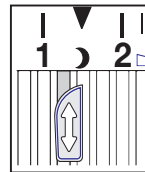

Fig. 4: blue economy clip for lower marking/limitation, e.g. 14°C

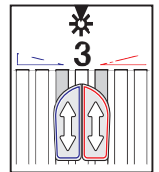

Fig. 5: blocking, e.g. 20°C

Limiting of a Temperature Setting

Upper limiting of the temperature range

In this case the **red economy clip** must be pulled back up to the stop (please see fig. 1), lift and remove it (please see fig. 2). Then the thermostatic head can be turned to the desired temperature, e.g. index figure 3 = 20°C. Afterwards the **red economy clip** must be inserted in the groove **right** to the index figure 3 (please see fig. 3) and the clip pushed **forward up to the stop**.

Now every temperature setting up to the index figure 3 will be possible when turning the thermostatic head. Any temperature setting above the index figure 3 will be impossible.

Lower marking of the temperature range

For this purpose the **blue economy clip** must be pulled back with your thumb up to the stop, lift and remove the clip. The thermostatic head can now be turned and set to the desired temperature, e.g. moon symbol = 14°C. Thereafter, the **blue economy clip** must be inserted **left** to the moon symbol (please see fig. 4) and the clip be pushed **forward up to the stop**.

Now any temperature setting can only be made up to the moon symbol by turning the thermostatic head. Temperature settings which are below the moon symbol can only be made after removing the said limitation.

Removing the limitation

For this purpose, the corresponding economy clip must be pulled back up to the stop with your thumb. Any desired temperature setting can now be made.

Blocking of a temperature setting

For blocking a temperature setting **both economy clips** must be pulled back (please see fig. 1), the clips must be lifted and removed (please see fig. 2).

The thermostatic head must now be turned to the desired temperature setting, e.g. index-figure 3 = 20°C. Then the **red economy clip** is to be inserted in the groove **right** of the index figure 3 (please see fig. 5) and be pushed forward up to the stop. Thereafter the **blue economy clip** must be inserted in the groove **left** of the index figure 3 (please see fig. 5) and be pushed up to the stop. The thermostatic head cannot be deregulated in any direction.

Removing of the blocking.

For this purpose the **red** and the **blue** or, if need be, both economy clips must be pulled back up to the stop. Any desired temperature setting will now be possible again.

Disturbances - Causes - Remedies

Any measures in order to remove disturbances in your heating system should either be judged or be eliminated by a specialist. Please apply to your installer or approach Heimeier directly (see reverse page of this brochure).

Radiator does not heat or heats insufficiently only

Possible causes

- The temperature setting of the thermostatic valve is below the actual room temperature
- Air in the radiator
- Heating system supplies either insufficient or no heating energy at all

Remedies/comments

- External heat influences lead to an increased room temperature. Thus, the thermostatic valve throttles or even stops the hot water supply to the radiator
- Vent the radiator
- Arrange for checking of heating curve, circulation pump, time programme, hot water generator, etc.

The radiator remains heated up even with a closed thermostatic valve

Possible causes

- In case of a continuous window ventilation (tilted window position) and low outside temperatures, the room temperature drops below the lowest temperature setting on the thermostatic valve
- Valve seat is contaminated or soiled, i.e. the thermostatic head cannot shut off

Remedies/comments

- Ventilation to be short but intensive
- Have the foreign body removed.

The thermostatic head cannot be turned or only be moved in a limited manner

Possible causes

- The thermostatic head was internally limited or blocked, e.g. a temperature setting was blocked or a setting range was limited towards a higher or lower level and, therefore, this adjustment cannot be changed from outside

Remedies/comments

- Either the blocking or limiting functions must be cancelled.

Room temperature is distinctly below the set temperature

Possible causes

- The thermostatic valve with incorporated sensor is covered with curtains, radiator covers or panelling etc.
- The thermostatic valve with incorporated sensor is mounted in vertical position
- The nominal performance of the radiator is insufficient in relation to the size of the room
- The heating system does not supply sufficient energy

Remedies/comments

- Take care that the thermostatic valve will be exposed to the circulating air of the room without any obstacle or have a remote sensor or remote dial installed
- Arrange for installation of a remote sensor or remote dial
- Have the heating curve or the radiator performance adapted
- Arrange for checking of heating curve, circulation pump, time programme, heat generator, etc.

Room temperature is distinctly above the set temperature

Possible causes

- The thermostatic valve does not capture the room temperature but is influenced by colder air, e.g. draught
- External heat influences could cause an increase of the room temperature although the thermostatic valve did shut off the supply of hot water to the radiator

Remedies/comments

- Take care that the thermostatic valve will be exposed to the circulating air of the room without any obstacle
- Thermostatic valves utilize the external heat supplied free of charge for room heating and, thus save energy

Noise in the thermostatic valve

Possible causes

- Excess differential pressure
- Air in the heating system
- Wrong flow direction passes through the radiator

Remedies/comments

- Arrange for reduction of pump pressure or have the hot water distribution checked
- Vent the heating system, refill water
- Arrange for the flow direction to be corrected or have a corresponding valve installed

Thermolux K with remote sensor

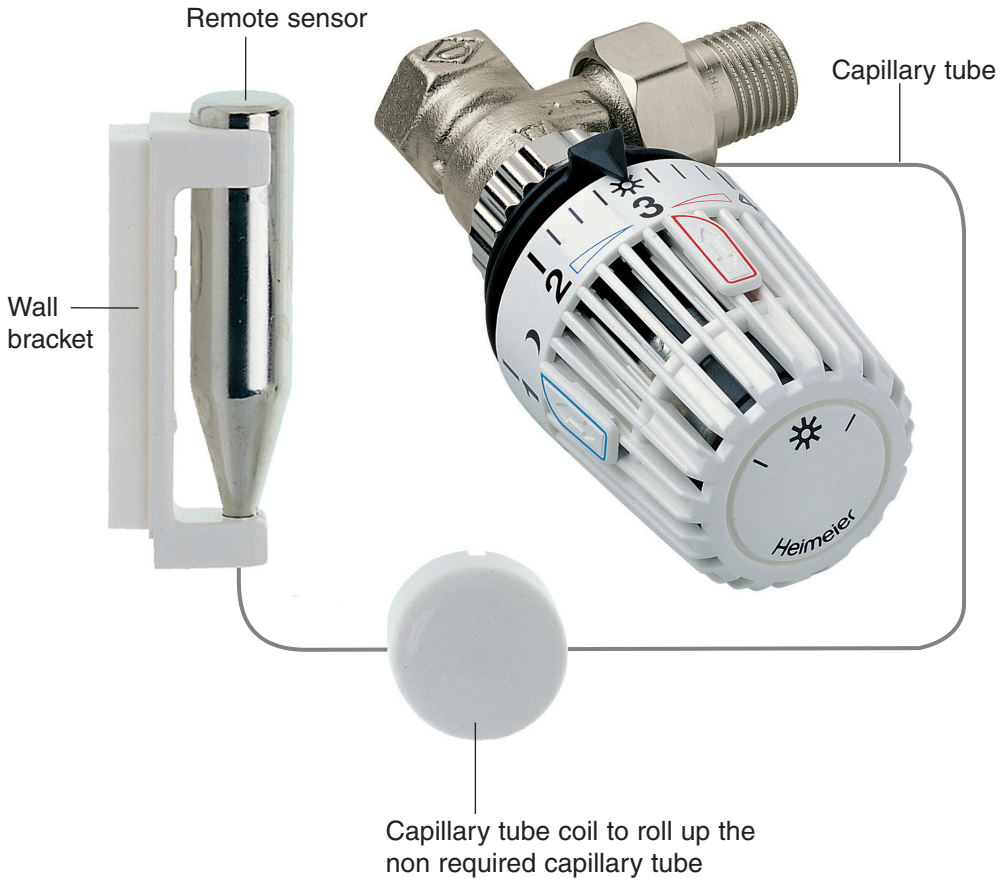

For this product, the main part of the temperature sensing liquid is situated in the remote sensor, contrary to the Thermolux K with built-in-sensor, and actuates from there via the capillary tube the corrugated tube in the thermostatic head.

But otherwise the functional principle is equal to the Thermolux K thermostatic valve with built-in sensor (please see page 2). Even the operation and the outfit are identical (please see page 1).

Accessories

With E-Pro achieving substantial energy savings is child's play.

E-Pro enables an automatic reduction of roomtemperature up to 4 °C, without time-consuming programming – and can be done by anyone at any time.

Perfect for rooms that are only used at times or in different ways, such as bathroom, kitchen, living room or bedroom.

In principle E-Pro has two buttons which are used to carry out individual time programming practically in passing. In this case a simple push of the button replaces the typical situation of turning the thermostatic valve down or up.

E-Pro is the modern partner of the HEIMEIER thermostatic valve – regardless whether it is already on hand or for a new installation. Energy savings of up to 20 percent – this cannot be done any more easily or inexpensively!

For further information regarding E-Pro please approach Heimeier directly – or contact your installer (see reverse page of this brochure).



Useful comments

Correct venting

Venting should not be used to control the room temperature but only to exchange stagnant air for oxygen-rich air. Venting should be short but intensive, i.e. windows should be fully opened for a short time. But during such venting the thermostatic head should be turned back to the anti-frost protection position.

After venting the previous temperature setting can easily be found again when using the economy clips (marking, limitation).

Saving by using cost-free external heat

Such external heat sources are e.g. lamps, insolation, electric appliances, people staying in the room etc.

This external heat has an influence on the room temperature and, in turn, on the thermostatic valve (please see page 2).

Should the so generated heat in the room lead to a higher room temperature than the temperature setting on the thermostatic head, the thermostatic valve will shut off the hot water supply to the radiator and the radiator will cool off.

Technical Data

	Heimeier Thermolux K	Requirements acc. to European standard DIN EN 215
Setting range	from 6 °C up to 28 °C	
Anti-frost protection	at 6 °C	
Max. sensor temperature	50 °C	
Hysteresis	0,2 K	max. 1 K
Differential pressure influence	0,3 K	max. 1 K
Water temperature influence (built-in sensor)	< 0,4 K	max. 1,5 K
Water temperature influence (remote sensor)	< 0,3 K	max. 0,75 K

Notes:

List of Headwords

Keywords	Page	Keywords	Page
Alcoves	4	Noises	11
Accessories	13	Office	6
Anti-frost protection	3, 6, 7	Panelling	13
Basement	6	Porch	6
Basic setting	1, 7	Pump	10, 11
Bath room	6	Radiator cover	4
Bed room	6	Radiator panelling	4
Blocking	9	Reduced performance	3, 6, 7
Capillary tube	12	Regulating	6, 7
Cellar	6	Remote dial	4, 5
Childrens room	6	Remote controller	4, 5
Cleaning	3	Remote sensor	4, 12
Comfortableness	7	Room temperature	2, 6, 7, 14
Corrugated tube	2	Sens of rotation	1
Curtain(s)	4	Sensor	2, 4
Dining room	6	Service	3
Disturbance(s)	10	Setting aid	7
Economy clip(s)	1, 3, 8, 9	Setting arrow	1, 7
Excess temperature	5	Short information	1
External heat source	14	Short instructions	3, 6
Function	2	Sleeping room	6
Furniture (outfit)	5	Special features	3
Graduation line	1, 7	Stair-case	6
Hall	6	Study	6
Heat accumulation	5	Sun symbol	7
Heat generator	10, 11	Swimming pool	6
Heating cost	4	Technical data	14
Heating curve	10, 11	Temperature controller	2
Hobby room	6	Temperature sensor	2
Important notes	3	Temperature setting(s)	6
Index figure(s)	7	Thermostatic head	2
Insolation	5	Thermostatic valve body	2
Intermediate adjustment(s)	7	Underfloor convector	5
Kitchen	6	Useful comments	14
Limitation	9	Valve seat	2
Living room	6	Valve spindle	2
Maintenance	3	Venting	14
Marking	8	Visually handicapped person(s)	1, 3, 7
Moon symbol	6, 7	Zero°C position	6
Mounting instructions	4, 5	Time programming	13
Night performance, reduced	3, 6, 7		15

Your installer



Theodor Heimeier Metallwerk GmbH
Postfach 1124, 59592 Erwitte, Germany
Telephone +49 2943 891-0
Fax +49 2943 891-100
www.heimeier.com

Printed on paper bleached without the use of chlorine.
Subject to technical alterations.

Consumer brochure AS
6086-18.480 / 06.06
012662TELE