

SINGLE-DOUBLE PIPE VALVES FOR PANEL RADIATORS

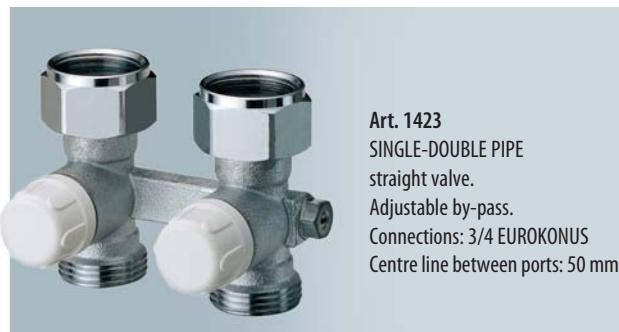

Art. 1421
SINGLE-DOUBLE PIPE
angled valve.
Adjustable by-pass.
Connections: 3/4 EUROKONUS
Centre line between ports: 50 mm



Art. 1423
SINGLE-DOUBLE PIPE
straight valve.
Adjustable by-pass.
Connections: 3/4 EUROKONUS
Centre line between ports: 50 mm



Art. 1422
SINGLE-DOUBLE PIPE
angled valve.
Adjustable by-pass.
Connections: FAR 24 x 19
Centre line between ports: 50 mm



Art. 1424
SINGLE-DOUBLE PIPE
straight valve.
Adjustable by-pass.
Connections: FAR 24 x 19
Centre line between ports: 50 mm

1. DESCRIPTION

Valves for panel radiators are available with FAR or eurokonus connections in straight or angled versions. Connection to the radiator is made by means of an adjustable nut. We offer two different types of adapter depending on the kind of radiator - an

adapter for 1/2" female connection and another for 3/4" eurokonus connection. A lateral screw adjustment makes it possible to change a single-pipe valve into a double-pipe valve and vice-versa.



Art. 6080
Adapters for
Arts. 1421-1422-1423-1424
For panel radiators with 3/4"
male connection

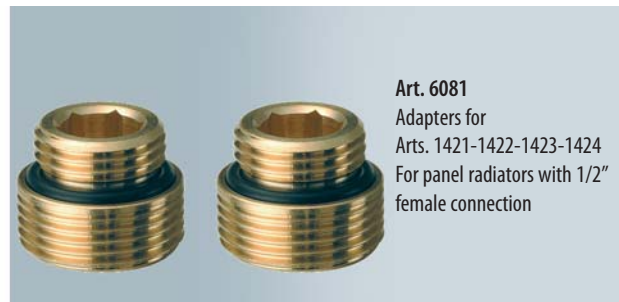

Art. 6081
Adapters for
Arts. 1421-1422-1423-1424
For panel radiators with 1/2"
female connection

1. 3/4" threaded nut
2. White plastic cap
3. By-pass regulating screw
4. FAR connections for copper, plastic and multilayer pipe or 3/4" eurokonus
5. Art. 6080
6. Flat-faced sealing seat between valve and adapter
7. Art. 6081

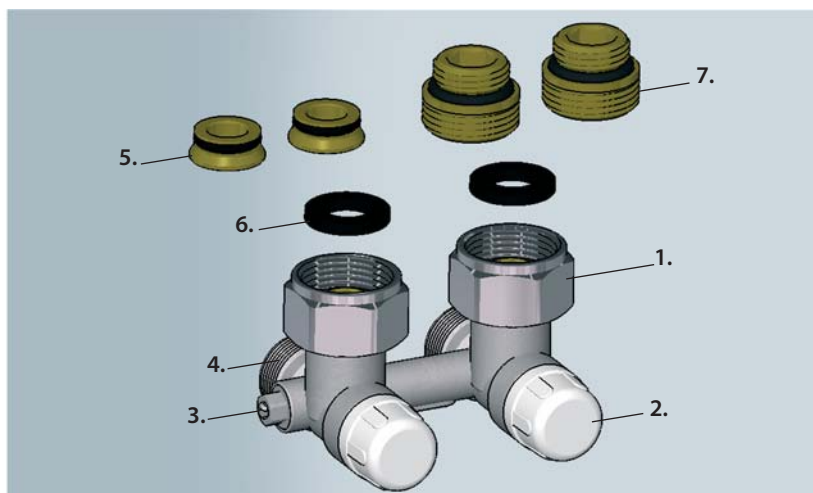

2. INSTALLATION

SECTIONED RADIATOR

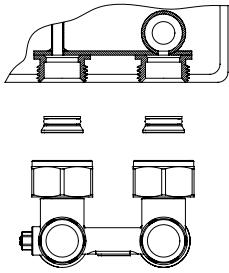

- 1) Insert the adapters into the radiator connections
- 2) Position the valve and tighten the nuts

SECTIONED RADIATOR

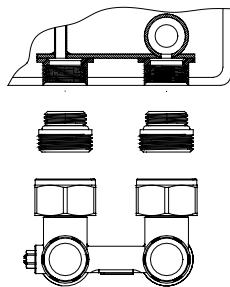

- 1) Insert the adapters into the radiator connections
- 2) Position the valve and tighten the nuts

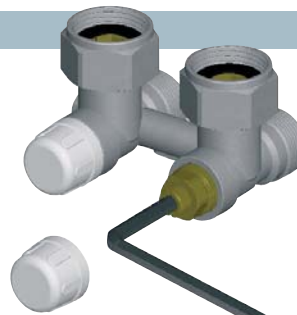

LOCKSHIELD VALVE REGULATION

In order to shut off a radiator from the system or to effect circuit balancing, proceed as follows: unscrew the white plastic cap, then use a 5mm wrench as shown in the illustration.

Example of installation on a panel radiator

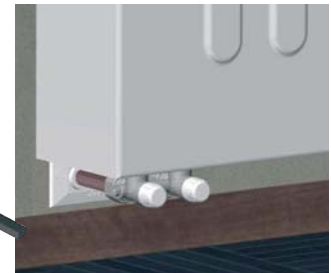

3. BY-PASS REGULATION

It is possible to adjust the by-pass flow with the aid of a simple screwdriver. The by-pass can also be totally closed, in which case the valve becomes a double-pipe valve.

Adjusting the by-pass permits variation of the flow to the radiator.



TC: TOTALLY CLOSED BY-PASS
TA: TOTALLY OPEN BY-PASS

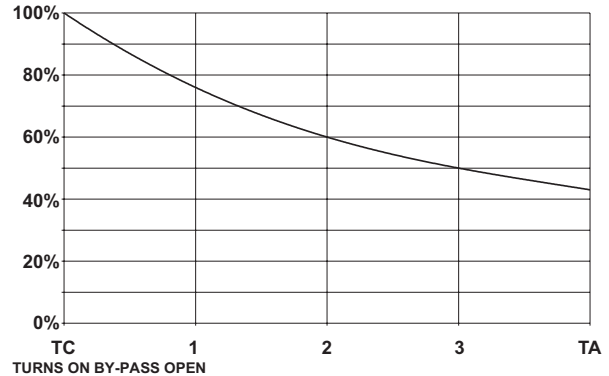

TOTALLY OPEN BY-PASS: SINGLE-PIPE VALVE

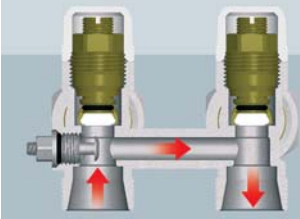

TOTALLY CLOSED BY-PASS: DOUBLE-PIPE VALVE

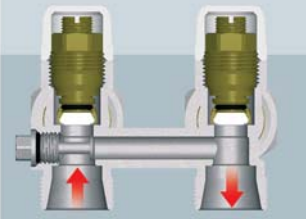

The diagram shows the flow variation in the radiator depending on the number of turns of the by-pass screw. With a totally open by-pass the flow to the radiator is about 45%.

4. TECHNICAL FEATURES

Nominal pressure:	10 bar
Max. working temperature:	95° C
Compatible fluid:	Water

5. FLUID DYNAMIC FEATURES

